

**PowerLite 107/108/109W/970/980W/990U
User's Guide**

Contents

PowerLite 107/108/109W/970/980W/990U User's Guide	9
Introduction to Your Projector	10
Projector Features.....	10
Product Box Contents.....	11
Additional Components	12
Additional Projector Software and Manuals	13
Optional Equipment and Replacement Parts.....	14
Warranty and Registration Information	15
Notations Used in the Documentation	15
Where to Go for Additional Information	16
Projector Part Locations	16
Projector Parts - Front/Top	17
Projector Parts - Rear	18
Projector Parts - Base.....	19
Projector Parts - Control Panel	20
Projector Parts - Remote Control.....	22
Setting Up the Projector	25
Projector Placement.....	25
Projector Setup and Installation Options	25
Projection Distance.....	27
Projector Connections	30
Connecting to Computer Sources.....	30
Connecting to a Computer for USB Video and Audio.....	30
Connecting to a Computer for VGA Video.....	31
Connecting to a Computer for HDMI Video and Audio	32
Connecting to a Computer for USB Mouse Control.....	33
Connecting to a Computer for Sound.....	34
Connecting to Video Sources	34
Connecting to an HDMI Video Source	34
Connecting to an MHL-Compatible Device	35

Connecting to a Component Video Source	36
Connecting to a Composite Video Source	37
Connecting to a Video Source for Sound	37
Connecting External Output Devices	38
Connecting to an External Computer Monitor	38
Connecting to External Speakers.....	39
Connecting a Microphone	40
Connecting to External USB Devices	41
USB Device Projection.....	41
Connecting a USB Device or Camera to the Projector	42
Selecting the Connected USB Source	43
Disconnecting a USB Device or Camera From the Projector	43
Connecting to a Document Camera	43
Installing Batteries in the Remote Control	44
Opening the Lens Cover	46
Using the Projector on a Network	47
Wired Network Projection	47
Connecting to a Wired Network	47
Selecting Wired Network Settings	48
Wireless Network Projection	51
Installing the Wireless LAN Module	52
Using a QR Code to Connect a Mobile Device	54
Using Quick Wireless Connection (Windows).....	56
Selecting Wireless Network Settings Manually.....	58
Wireless LAN Menu Settings	61
Selecting Wireless Network Settings in Windows.....	62
Selecting Wireless Network Settings on Mac	62
Setting Up Wireless Network Security	63
Setting Up Projector Network E-Mail Alerts	64
Network Projector E-mail Alert Messages	65
Setting Up Monitoring Using SNMP	65
Controlling a Networked Projector Using a Web Browser	66

Using Basic Projector Features	70
Turning On the Projector	70
Using the Home Screen.....	72
Turning Off the Projector	73
Selecting the Language for the Projector Menus.....	75
Adjusting the Image Height	76
Image Shape.....	77
Correcting Image Shape with the Horizontal Keystone Slider	77
Correcting Image Shape with the Keystone Buttons.....	78
Correcting Image Shape with Quick Corner	80
Resizing the Image with the Zoom Ring.....	82
Focusing the Image Using the Focus Ring.....	82
Remote Control Operation	83
Using the Remote Control as a Wireless Mouse	84
Using the Remote Control as a Pointer.....	85
Selecting an Image Source	85
Projection Modes	87
Changing the Projection Mode Using the Remote Control	88
Changing the Projection Mode Using the Menus.....	88
Image Aspect Ratio	89
Changing the Image Aspect Ratio.....	89
Available Image Aspect Ratios	90
Color Mode.....	91
Changing the Color Mode.....	92
Available Color Modes.....	92
Turning On Auto Iris.....	93
Controlling the Volume with the Volume Buttons.....	94
Projecting a PC Free Presentation	94
Supported PC Free File Types	94
Starting a PC Free Slide Show	95
Starting a PC Free Movie Presentation	97
PC Free Display Options	98

Adjusting Projector Features	100
Shutting Off the Picture and Sound Temporarily	100
Stopping Video Action Temporarily	101
Zooming Into and Out of Images	102
Projector Security Features	103
Password Security Types	103
Setting a Password	103
Selecting Password Security Types	105
Entering a Password to Use the Projector	106
Saving a User's Logo Image to Display	107
Locking the Projector's Buttons	109
Unlocking the Projector's Buttons	110
Installing a Security Cable	111
Projector Identification System for Multiple Projector Control	111
Setting the Projector ID	112
Setting the Remote Control ID	112
Matching Multiple-Projector Display Quality	113
Projecting Two Images Simultaneously	115
Copying Menu Settings Between Projectors	117
Saving Settings to a USB Flash Drive	117
Transferring Settings from a USB Flash Drive	119
Saving Settings to a Computer	120
Transferring Settings from a Computer	122
Adjusting the Menu Settings	126
Using the Projector's Menus	126
Image Quality Settings - Image Menu	128
Input Signal Settings - Signal Menu	131
Projector Feature Settings - Settings Menu	133
Projector Setup Settings - Extended Menu	136
Projector Network Settings - Network Menu	139
Projector Setup Settings - ECO Menu	141
Projector Information Display - Info Menu	143
Event ID Code List	144

Projector Reset Options - Reset Menu	145
Maintaining and Transporting the Projector	147
Projector Maintenance	147
Cleaning the Lens.....	147
Cleaning the Projector Case.....	148
Air Filter and Vent Maintenance	148
Cleaning the Air Filter and Vents.....	149
Replacing the Air Filter.....	149
Projector Lamp Maintenance.....	152
Replacing the Lamp	153
Resetting the Lamp Timer.....	157
Replacing the Remote Control Batteries	158
Transporting the Projector.....	159
Solving Problems	161
Projection Problem Tips	161
Projector Light Status	162
Using the Projector Help Displays	165
Solving Image or Sound Problems	165
Solutions When No Image Appears.....	166
Solutions When Image is Incorrect Using the USB Display Function	167
Solutions When "No Signal" Message Appears.....	167
Displaying From a PC Laptop	168
Displaying From a Mac Laptop	169
Solutions When "Not Supported" Message Appears	169
Solutions When Only a Partial Image Appears	169
Solutions When the Image is Not Rectangular	170
Solutions When the Image Contains Noise or Static	170
Solutions When the Image is Fuzzy or Blurry	171
Solutions When the Image Brightness or Colors are Incorrect	172
Solutions to Sound Problems	173
Solving Projector or Remote Control Operation Problems	173
Solutions to Projector Power or Shut-Off Problems	174
Solutions to Problems with the Remote Control.....	174

Solutions to Password Problems	175
Solving Network Problems	176
Solutions When Wireless Authentication Fails	176
Solutions When You Cannot Access the Projector Through the Web	176
Solutions When the Image Contains Static During Network Projection	177
Solutions When Network Alert E-Mails are Not Received.....	177
Where to Get Help.....	178
Technical Specifications	180
General Projector Specifications	180
Projector Lamp Specifications	185
Remote Control Specifications	186
Projector Dimension Specifications.....	186
Projector Electrical Specifications	187
Projector Environmental Specifications.....	188
Projector Safety and Approvals Specifications.....	188
Supported Video Display Formats.....	188
USB Display System Requirements.....	191
Notices	192
Recycling.....	192
Important Safety Information	192
Important Safety Instructions.....	193
Restriction of Use	196
List of Safety Symbols (corresponding to IEC60950-1 A2).....	196
FCC Compliance Statement.....	199
Binding Arbitration and Class Waiver	200
Trademarks	203
Copyright Notice.....	204
A Note Concerning Responsible Use of Copyrighted Materials.....	204
Copyright Attribution	205

PowerLite 107/108/109W/970/980W/990U User's Guide

Welcome to the PowerLite 107/108/109W/970/980W/990U *User's Guide*.

For a printable PDF copy of this guide, [click here](#).

Introduction to Your Projector

Refer to these sections to learn more about your projector and this manual.

[Projector Features](#)

[Notations Used in the Documentation](#)

[Where to Go for Additional Information](#)

[Projector Part Locations](#)

Projector Features

Your projector includes these special features:

Bright, high-resolution projection system

- PowerLite 107: Up to 3500 lumens of color brightness (color light output) and 3500 lumens of white brightness (white light output)
- PowerLite 108: Up to 3700 lumens of color brightness (color light output) and 3700 lumens of white brightness (white light output)
- PowerLite 109W/970: Up to 4000 lumens of color brightness (color light output) and 4000 lumens of white brightness (white light output)
- PowerLite 980W/990U: Up to 3800 lumens of color brightness (color light output) and 3800 lumens of white brightness (white light output)

Note: Color brightness (color light output) and white brightness (white light output) will vary depending on usage conditions. Color light output measured in accordance with IDMS 15.4; white light output measured in accordance with ISO 21118.

- PowerLite 107/108/970: Native resolution of 1024 × 768 pixels (XGA)
- PowerLite 109W/980W: Native resolution of 1280 × 800 pixels (WXGA)
- PowerLite 990U: Native resolution of 1920 × 1200 pixels (WUXGA)

Flexible connectivity

- Plug-and-play 3-in-1 USB projection, audio, and mouse control for instant setup
- Wireless network support for projection, monitoring, and control via remote (requires the optional wireless LAN module)

- Projection from iOS devices, Android devices, and Chromebooks with the free Epson iProjection app; visit epson.com/iprojection (U.S.) or epson.ca/iprojection (Canada) for more information (requires the optional wireless LAN module)
- PC Free photo slide shows via connected USB memory devices or Epson document camera
- Two HDMI ports for multiple high-definition AV devices, including MHL support

Easy-to-use setup and operation features

- Epson's quick-connect on-screen QR code feature for easy wireless setup
- Low total cost of ownership with longer lamp life
- Automatic vertical keystone correction and innovative horizontal keystone correction slider for flexible projector placement
- Epson's Instant Off and Direct Power On features for quick setup and shut down
- Built-in closed captioning decoder (composite NTSC input signal only)

[Product Box Contents](#)

[Additional Components](#)

[Additional Projector Software and Manuals](#)

[Optional Equipment and Replacement Parts](#)

[Warranty and Registration Information](#)

Parent topic: [Introduction to Your Projector](#)

Product Box Contents

Save all the packaging in case you need to ship the projector. Always use the original packaging (or equivalent) when shipping.

Make sure your projector boxes included all of these parts:

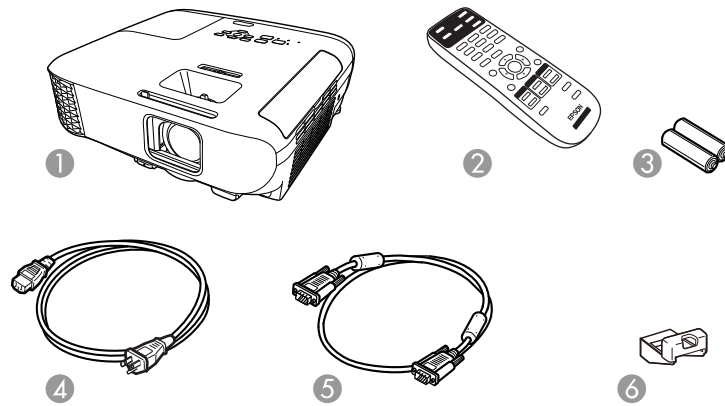

- 1 Projector
- 2 Remote control
- 3 Remote control batteries (two AA alkaline)
- 4 Power cord
- 5 VGA computer cable
- 6 Wireless LAN module cover

Parent topic: [Projector Features](#)

Related concepts

[Projector Connections](#)

Additional Components

Depending on how you plan to use the projector, you may need to obtain additional components.

Note: To connect a Mac that does not include a compatible video output port, you need to obtain an adapter that allows you to connect to an input port on the projector. Contact Apple for compatible adapter options. To connect a smartphone or tablet, you may need to obtain an adapter that allows you to connect to the projector. This allows you to mirror your smartphone or tablet screens, watch movies, and more. Contact your device manufacturer for compatible adapter options.

Unless listed as available from Epson in this table, see your local computer or electronics dealer for purchase information.

Signal or connection type	Additional component necessary
Composite video	RCA-style video or A/V cable
Component video	D-sub, 15-pin, component-to-VGA video cable or adapter Available for purchase from Epson or an authorized Epson reseller.
HDMI	Compatible HDMI cable Available for purchase from Epson or an authorized Epson reseller. Note: Older Mac computers (2009 and earlier) may not support HDMI audio.
USB	Compatible USB cable
MHL	MHL-compatible device or device with an integrated MHL connector, MHL cable, or HDMI cable and MHL adapter compatible with your device Available for purchase from Epson or an authorized Epson reseller.
Audio from certain ports	Commercially available audio cable compatible with your device

Parent topic: [Projector Features](#)

Additional Projector Software and Manuals

After connecting and setting up the projector, install the projector software from the included software CD, or download the software and manuals as necessary.

You can install the projector software programs listed here and view their manuals for instructions on using them.

Note: If you still need help after checking this manual and the sources listed here, you can use the Epson PrivateLine Support service to get help fast. For details, see "Where to Get Help".

Projector software	Manual	Description
Epson Projector Management (Windows only)	<i>Epson Projector Management Guide</i>	Lets you monitor and control your projector through the network. You can download the latest software and documentation from the Epson web site. Go to epson.com/support (U.S.) or epson.ca/support (Canada) and select your projector.
Epson iProjection (Windows/Mac)	<i>Epson iProjection Operation Guide</i>	Lets you project the computer screens of users over a network. You can download the latest software and documentation from the Epson web site. Go to epson.com/support (U.S.) or epson.ca/support (Canada) and select your projector.
Epson iProjection app	Instructions are included with the app	Lets you project from an iOS device, Android device, or Chromebook if your projector is connected to a network that includes a wireless access point. Visit epson.com/iprojection (U.S.) or epson.ca/iprojection (Canada) for more information.
—	<i>Open Source Software License</i>	You can download this document from the Epson web site. Go to epson.com/support (U.S.) or epson.ca/support (Canada) and select your projector.

Parent topic: [Projector Features](#)

Optional Equipment and Replacement Parts

You can purchase screens, other optional accessories, and replacement parts from an Epson authorized reseller. To find the nearest reseller, call 800-GO-EPSON (800-463-7766) in the U.S. or 800-807-7766 in Canada. Or you can purchase online at epsonstore.com (U.S. sales) or epsonstore.ca (Canadian sales).

Epson offers the following optional accessories and replacement parts for your projector:

Option or part	Part number
Genuine Epson replacement lamp (ELPLP96)	V13H010L96

Option or part	Part number
Replacement air filter (ELPAF32; PowerLite 107/108/109W)	V13H134A32
Replacement air filter (ELPAF55; PowerLite 970/980W/990U)	V13H134A55
Wireless LAN module (ELPAP10)	V12H731P02
Universal projector mount (ELPMBPJG)	V12H808001
Soft carrying case (ELPKS70)	V12H001K70
Accolade Duet portable projector screen	ELPSC80
Epson DC-07 USB document camera (ELPDC07)	V12H759020
Epson DC-13 document camera (ELPDC13)	V12H757020
Epson DC-21 document camera (ELPDC21)	V12H758020
HDMI audio video cable 3 feet (0.9 m) length	AV22300-03
HDMI audio video cable 6 feet (1.8 m) length	AV22300-06
1-Year Extended Exchange Service Plan	EPPEXPA1
2-Year Extended Exchange Service Plan	EPPEXPA2

Parent topic: [Projector Features](#)

Warranty and Registration Information

Your projector comes with a basic warranty that lets you project with confidence. For details, see the warranty that came with your projector.

In addition, Epson offers free Extra Care Road Service. In the unlikely event of an equipment failure, you won't have to wait for your unit to be repaired. Instead, Epson will ship you a replacement unit anywhere in the United States, Canada, or Puerto Rico. See the Extra Care Road Service brochure for details.

Register your product online at this site: epson.com/webreg.

Registering also lets you receive special updates on new accessories, products, and services.

Parent topic: [Projector Features](#)

Notations Used in the Documentation

Follow the guidelines in these notations as you read your documentation:

- **Warnings** must be followed carefully to avoid bodily injury.

- **Cautions** must be observed to avoid damage to your equipment.
- **Notes** contain important information about your projector.
- **Tips** contain additional projection information.

Parent topic: [Introduction to Your Projector](#)

Where to Go for Additional Information

Need quick help on using your projector? Here's where to look for help:

- Built-in help system
Press the **Home** button on the remote control or projector, select **Help**, and press **Enter** to get quick solutions to common problems.
- epson.com/support (U.S.) or epson.ca/support (Canada)
View FAQs (frequently asked questions) and e-mail your questions to Epson technical support 24 hours a day.
- If you still need help after checking this manual and any other sources listed here, you can use the Epson PrivateLine Support service to get help fast. For details, see "Where to Get Help".

Parent topic: [Introduction to Your Projector](#)

Related references

[Where to Get Help](#)

Projector Part Locations

Check the projector part illustrations to learn about the parts on your projector.

[Projector Parts - Front/Top](#)

[Projector Parts - Rear](#)

[Projector Parts - Base](#)

[Projector Parts - Control Panel](#)

[Projector Parts - Remote Control](#)

Parent topic: [Introduction to Your Projector](#)

Projector Parts - Front/Top

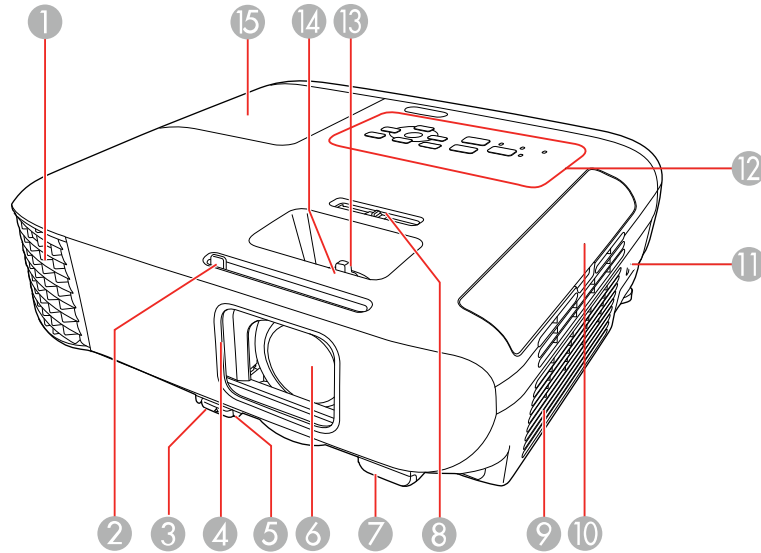

- 1 Exhaust vent
- 2 A/V Mute slide lever
- 3 Foot release lever
- 4 Lens cover
- 5 Front adjustable foot
- 6 Lens
- 7 Remote control receiver
- 8 Horizontal keystone slider
- 9 Air filter/intake vent
- 10 Air filter cover
- 11 Kensington security lock slot
- 12 Control panel
- 13 Zoom ring

- 14 Focus ring
- 15 Lamp cover

Parent topic: [Projector Part Locations](#)

Projector Parts - Rear

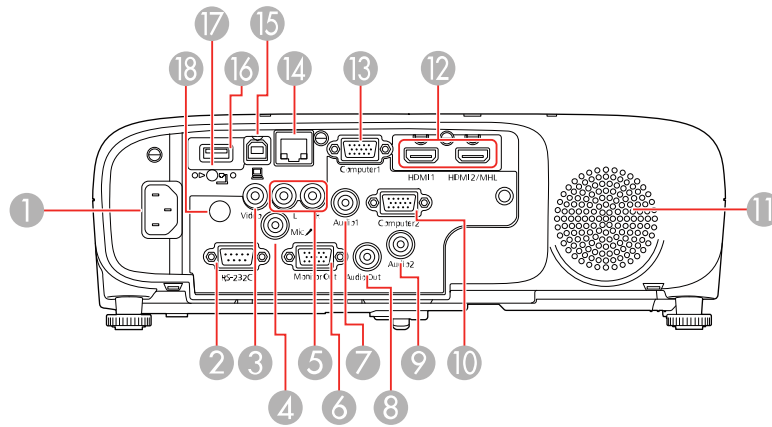

- 1 AC input
- 2 **RS-232C** port
- 3 **Video** port
- 4 **Mic** port
- 5 **L and R** audio ports
- 6 **Monitor Out** port
- 7 **Audio1** port
- 8 **Audio Out** port
- 9 **Audio2** port
- 10 **Computer2** port
- 11 Speaker
- 12 **HDMI1** and **HDMI2/MHL** ports

- 13 **Computer1** port
- 14 Network (LAN) port
- 15 USB-B port
- 16 USB-A port
- 17 Wireless LAN module cover screw
- 18 Remote receiver

Parent topic: [Projector Part Locations](#)

Projector Parts - Base

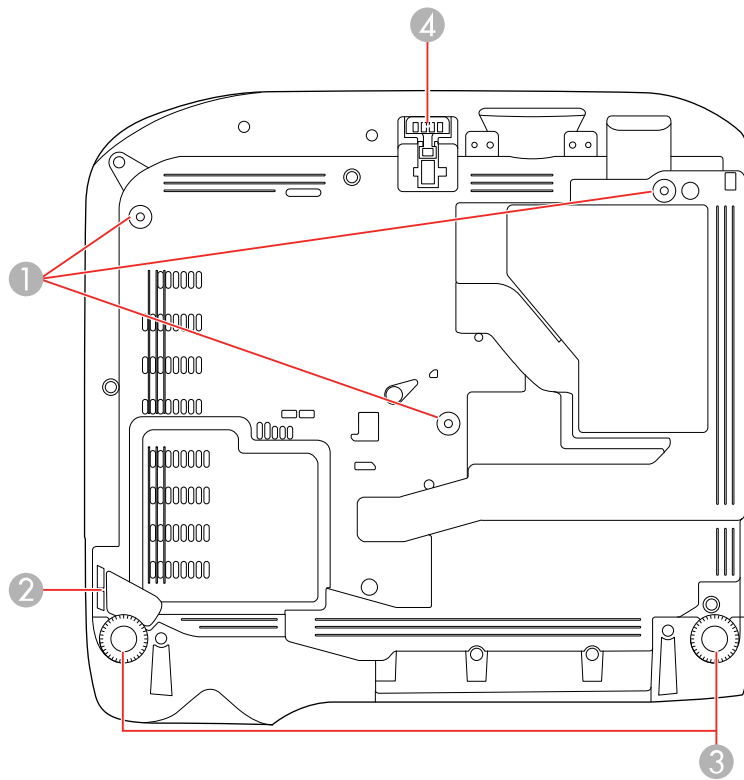

- 1 Ceiling mount holes (3)
- 2 Security cable attachment point
- 3 Rear feet
- 4 Front adjustable foot

Parent topic: [Projector Part Locations](#)

Projector Parts - Control Panel

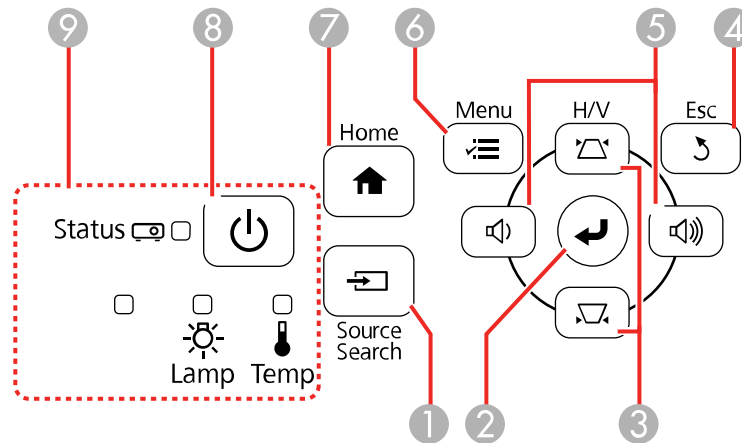

- 1 **Source Search** button (searches for connected video sources)
- 2 **Enter** button (selects options)
- 3 Vertical keystone adjustment buttons (displays the adjustment screen and adjusts screen shape) and arrow buttons
- 4 **Esc** button (cancels/exits functions)
- 5 Volume buttons (adjust speaker volume), horizontal keystone adjustment buttons, and arrow buttons
- 6 **Menu** button (accesses projector menu system)
- 7 **Home** button (displays Home screen)
- 8 Power button

9 Status lights

Parent topic: [Projector Part Locations](#)

Related references

[Projector Light Status](#)

Related tasks

[Using the Projector Help Displays](#)

Projector Parts - Remote Control

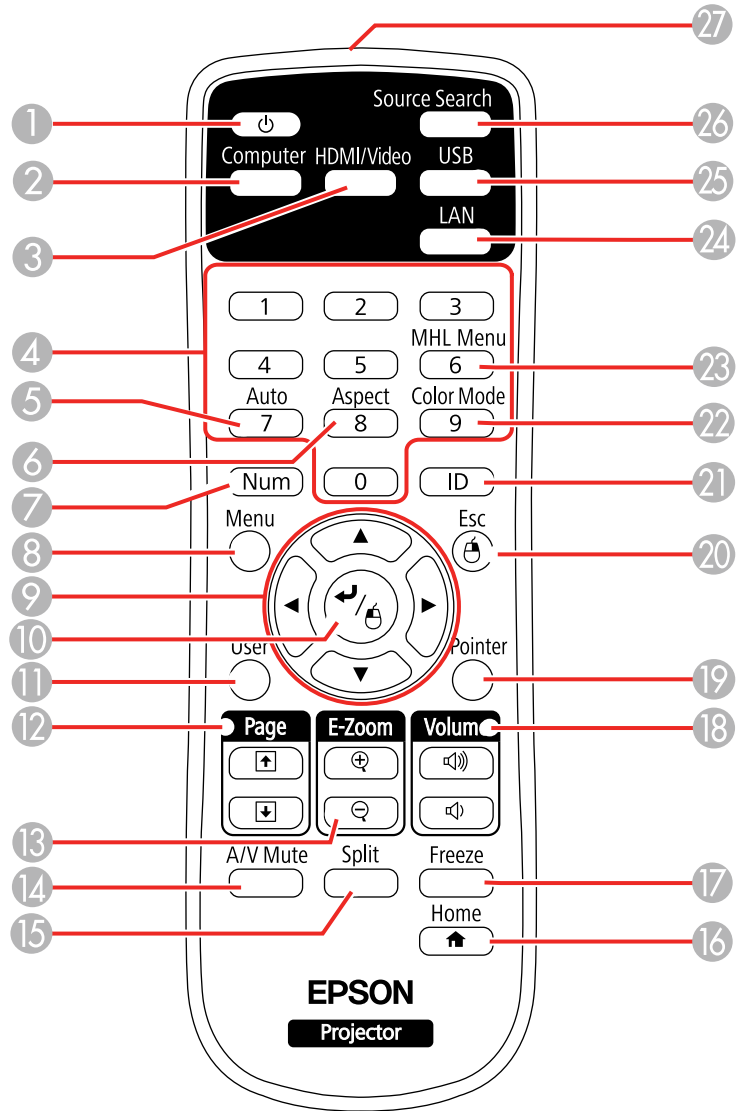

1 Power button

- 2 **Computer** button (cycles through connected computer sources)
- 3 **HDMI/Video** button (cycles through connected HDMI/video sources)
- 4 Numeric buttons (enter numbers when you hold down the **Num** button)
- 5 **Auto** button (automatically adjusts position, tracking, and sync settings when projecting from a computer using a VGA cable)
- 6 **Aspect** button (selects the image aspect ratio)
- 7 **Num** button (when held down, switches numeric buttons to number function)
- 8 **Menu** button (accesses projector menu system)
- 9 Arrow buttons (move through on-screen options and control wireless mouse functions)
- 10 Enter button (selects options and controls wireless mouse functions)
- 11 **User** button (customizable for different functions)
- 12 **Page** up/down buttons (control presentation slides)
- 13 **E-Zoom +/-** buttons (zoom into and out of the image)
- 14 **A/V Mute** button (turns off picture and sound)
- 15 **Split** button (splits the screen between two image sources)
- 16 **Home** button (accesses source selection, projector help information, and other features)
- 17 **Freeze** button (stops video action)
- 18 **Volume** up/down buttons (adjust speaker volume)
- 19 **Pointer** button (activates on-screen pointer)
- 20 **Esc** button (cancels/exits functions and controls wireless mouse functions)
- 21 **ID** button (selects which projector you want to control)
- 22 **Color Mode** button (selects display modes)
- 23 **MHL Menu** button (displays settings or performs functions for the MHL device)
- 24 **LAN** button (cycles through connected network sources)
- 25 **USB** button (cycles through connected USB sources)
- 26 **Source Search** button (searches for connected sources)
- 27 Remote control signal emitter (emits remote control signals)

Parent topic: [Projector Part Locations](#)

Setting Up the Projector

Follow the instructions in these sections to set up your projector for use.

[Projector Placement](#)

[Projector Connections](#)

[Installing Batteries in the Remote Control](#)

[Opening the Lens Cover](#)

Projector Placement

You can place the projector on almost any flat surface to project an image.

You can also install the projector in a ceiling mount if you want to use it in a fixed location.

Keep these considerations in mind as you select a projector location:

- Place the projector on a sturdy, level surface or install it using a compatible mount.
- Leave plenty of space around and under the projector for ventilation, and do not place it on top of or next to anything that could block the vents.
- Position the projector within reach of a grounded electrical outlet or extension cord.

[Projector Setup and Installation Options](#)

[Projection Distance](#)

Parent topic: [Setting Up the Projector](#)

Projector Setup and Installation Options

You can set up or install your projector in the following ways:

Front

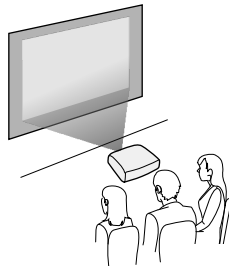

Rear

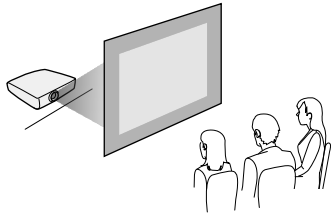

Front Ceiling

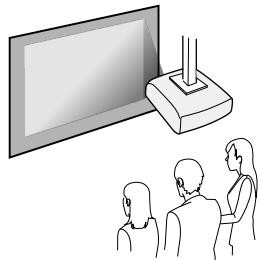

Rear Ceiling

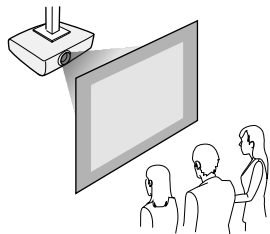

Wherever you set up the projector, make sure to position it squarely in front of the center of the screen, not at an angle, if possible.

If you project from the ceiling or from the rear, be sure to select the correct **Projection** option in the projector's menu system.

Parent topic: [Projector Placement](#)

Related references

[Projector Setup Settings - Extended Menu](#)

Projection Distance

The distance at which you place the projector from the screen determines the approximate size of the image. The image size increases the farther the projector is from the screen, but can vary depending on the zoom factor, aspect ratio, and other settings.

Use the tables here to determine approximately how far to place the projector from the screen based on the size of the projected image. (Conversion figures may have been rounded up or down.) You can also use the Projection Distance Calculator [here](#) (U.S.), [here](#) (Canada), or [here](#) (Caribbean).

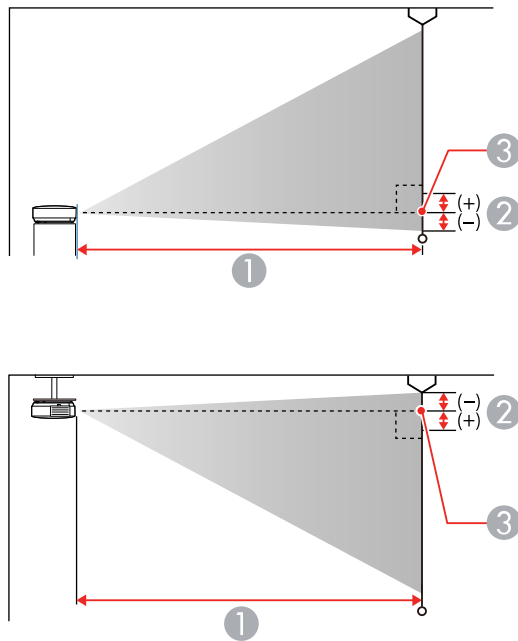

- 1 Projection distance
- 2 Distance from the center of the lens to the base of the image

3 Center of lens

PowerLite 107/108

4:3 Aspect Ratio Image or Screen		
Screen or image size	Projection distance (1) Wide to Tele	Offset from lens center (2)
50 inches	59 to 71 inches (150 to 180 cm)	-3.3 inches (-8 cm)
80 inches	95 to 114 inches (241 to 290 cm)	-5.3 inches (-14 cm)
100 inches	119 to 143 inches (302 to 363 cm)	-6.7 inches (-17 cm)
150 inches	179 to 215 inches (454 to 546 cm)	-10 inches (-25 cm)

PowerLite 970

16:10 Aspect Ratio Image or Screen		
Screen or image size	Projection distance (1) Wide to Tele	Offset from lens center (2)
50 inches	55 to 90 inches (140 to 229 cm)	-3.1 inches (-8 cm)
80 inches	89 to 145 inches (226 to 368 cm)	-5 inches (-13 cm)
100 inches	111 to 181 inches (283 to 460 cm)	-6.3 inches (-16 cm)
150 inches	168 to 272 inches (426 to 692 cm)	-9.4 inches (-24 cm)

PowerLite 109W/980W

16:10 Aspect Ratio Image or Screen		
Screen or image size	Projection distance (1) Wide to Tele	Offset from lens center (2)
50 inches	55 to 66 inches (139 to 168 cm)	-2.4 inch (-6 cm)
80 inches	88 to 106 inches (225 to 270 cm)	-3.8 inches (-10 cm)
100 inches	111 to 133 inches (271 to 338 cm)	-4.7 inches (-12 cm)
150 inches	167 to 200 inches (424 to 509 cm)	-7.1 inches (-18 cm)

PowerLite 990U

16:10 Aspect Ratio Image or Screen		
Screen or image size	Projection distance (1) Wide to Tele	Offset from lens center (2)
50 inches	59 to 94 inches (149 to 240 cm)	-2.4 inches (-6 cm)
80 inches	94 to 152 inches (240 to 386 cm)	-3.9 inches (-10 cm)
100 inches	118 to 190 inches (301 to 483 cm)	-4.8 inches (-12 cm)
150 inches	178 to 286 inches (452 to 727 cm)	-7.2 inches (-18 cm)

Parent topic: [Projector Placement](#)

Projector Connections

See these sections to connect the projector to a variety of projection sources.

Caution: If you will use the projector at altitudes above 4921 feet (1500 m), turn on **High Altitude Mode** to ensure the projector's internal temperature is regulated properly.

[Connecting to Computer Sources](#)

[Connecting to Video Sources](#)

[Connecting External Output Devices](#)

[Connecting to External USB Devices](#)

[Connecting to a Document Camera](#)

Parent topic: [Setting Up the Projector](#)

Related references

[Projector Setup Settings - Extended Menu](#)

Connecting to Computer Sources

Follow the instructions in these sections to connect a computer to the projector.

[Connecting to a Computer for USB Video and Audio](#)

[Connecting to a Computer for VGA Video](#)

[Connecting to a Computer for HDMI Video and Audio](#)

[Connecting to a Computer for USB Mouse Control](#)

[Connecting to a Computer for Sound](#)

Parent topic: [Projector Connections](#)

Connecting to a Computer for USB Video and Audio

If your computer meets the system requirements, you can send video and audio output to the projector through the computer's USB port (preferably USB 2.0). Connect the projector to your computer using a USB cable.

Note: An HDMI connection is recommended for projecting content requiring high bandwidth.

1. Turn on your computer.

2. Connect the cable to your projector's **USB-B** port.

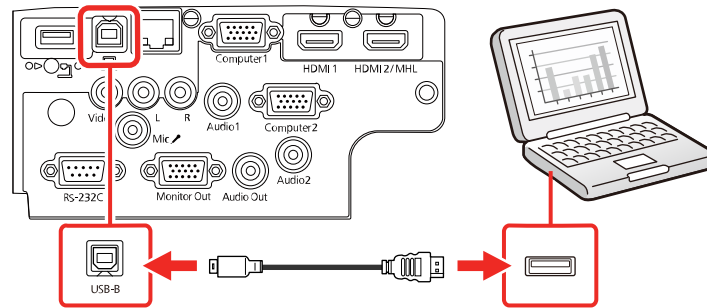

3. Connect the other end to any available USB port on your computer.
4. Do one of the following:
 - **Windows 10/Windows 8.x:** Click **EPSON_PJ_UD** when it appears on the desktop, then select **Run EMP_UDSE.EXE** in the dialog box that appears to install the Epson USB Display software.
 - **Windows 7/Windows Vista:** Select **Run EMP_UDSE.EXE** in the dialog box that appears to install the Epson USB Display software.
 - **Mac:** The USB Display setup folder appears on your screen. Select **USB Display Installer** and follow the on-screen instructions to install the Epson USB Display software.

Follow any on-screen instructions. You need to install this software only the first time you connect the projector to the computer.

The projector displays the image from your computer's desktop and outputs sound, if your presentation contains audio.

Parent topic: [Connecting to Computer Sources](#)

Connecting to a Computer for VGA Video

You can connect the projector to your computer using a VGA computer cable.

Note: To connect a Mac that includes only a Mini DisplayPort, Thunderbolt port, or Mini-DVI port for video output, you need to obtain an adapter that allows you to connect to the projector's VGA video port. Contact Apple for compatible adapter options.

1. If necessary, disconnect your computer's monitor cable.
2. Connect the VGA computer cable to your computer's monitor port.

3. Connect the other end to a **Computer** port on the projector.

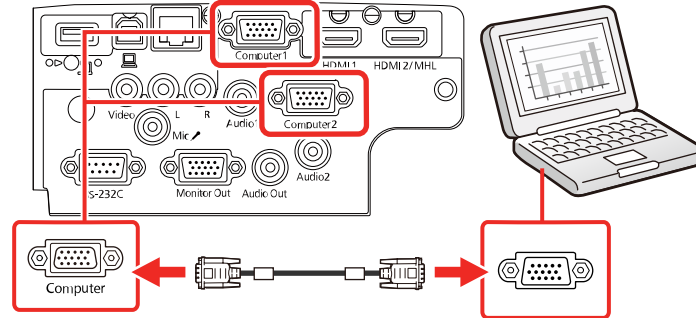

4. Tighten the screws on the VGA connector.

Parent topic: [Connecting to Computer Sources](#)

Related tasks

[Connecting to a Computer for Sound](#)

Connecting to a Computer for HDMI Video and Audio

If your computer has an HDMI port, you can connect it to the projector using an optional HDMI cable.

Note: To connect a Mac that includes only a Mini DisplayPort, Thunderbolt port, or Mini-DVI port for video output, you need to obtain an adapter that allows you to connect to the projector's **HDMI** port. Contact Apple for compatible adapter options.

1. Connect the HDMI cable to your computer's HDMI output port.
2. Connect the other end to the projector's **HDMI** port.

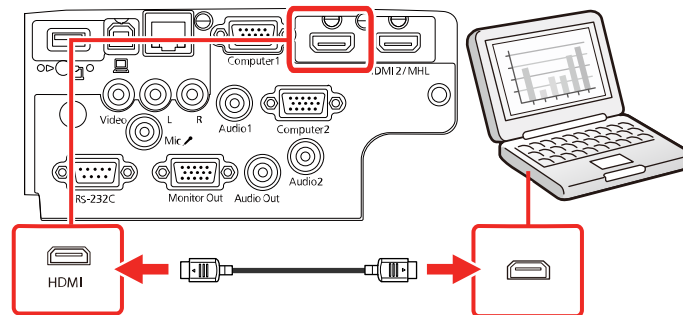

Note: The projector converts the digital audio signal sent from your computer into a mono analog signal for the internal speaker or a stereo analog signal if you are connecting to external speakers. (Make sure the HDMI audio playback device on your computer's audio settings is set to **EPSON PJ.**)

Note: The projector converts the digital audio signal sent from your computer into a mono analog signal for the internal speaker. If you have problems hearing audio through the HDMI connection, connect one end of an optional 3.5 mm stereo mini-jack audio cable to the projector's **Audio** port and the other end to your computer's audio out port. Then select the audio port you connected to as the **HDMI Audio Output** setting in the Extended menu.

Parent topic: [Connecting to Computer Sources](#)

Connecting to a Computer for USB Mouse Control

If you connected your computer to a **Computer**, **USB-B**, or **HDMI** port on the projector, you can set up the remote control to act as a wireless mouse. This lets you control projection at a distance from your computer. To do this, connect the projector to your computer using a USB cable, if it is not connected already.

1. Connect a USB cable to your projector's **USB-B** port.

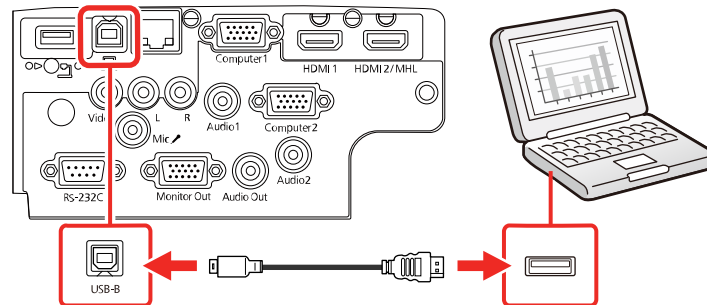

2. Connect the other end to any available USB port on your computer.
3. If necessary, configure your computer to work with an external USB mouse. See your computer documentation for details.

Parent topic: [Connecting to Computer Sources](#)

Related tasks

[Using the Remote Control as a Wireless Mouse](#)

Connecting to a Computer for Sound

If your computer presentation includes sound and you did not connect it using the projector's **USB-B** or **HDMI** port, you can still play sound through the projector's speaker system. Connect an optional stereo mini-jack adapter cable (with one 3.5 mm mini-plug and two RCA plugs).

1. Connect the audio cable to your laptop's headphone or audio-out jack, or your desktop's speaker or audio-out port.
2. Connect the other end to the projector's **Audio** ports.

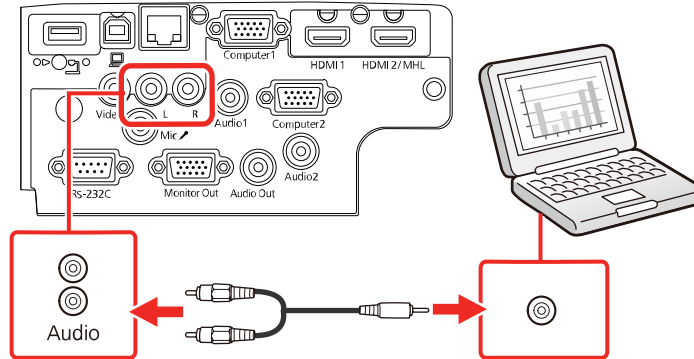

Parent topic: [Connecting to Computer Sources](#)

Connecting to Video Sources

Follow the instructions in these sections to connect video devices to the projector.

[Connecting to an HDMI Video Source](#)

[Connecting to an MHL-Compatible Device](#)

[Connecting to a Component Video Source](#)

[Connecting to a Composite Video Source](#)

[Connecting to a Video Source for Sound](#)

Parent topic: [Projector Connections](#)

Connecting to an HDMI Video Source

If your video source has an HDMI port, you can connect it to the projector using an optional HDMI cable. The HDMI connection provides the best image quality.

1. Connect the HDMI cable to your video source's HDMI output port.

2. Connect the other end to the projector's HDMI port.

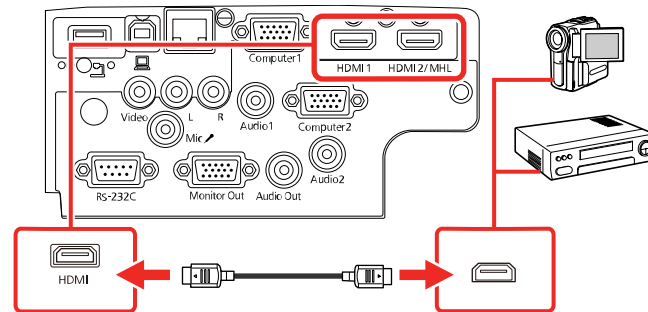

Note: The projector converts the digital audio signal sent from your video source into a mono analog signal for the internal speaker or a stereo analog signal if you are connecting to external speakers.

Note: If you have problems hearing audio through the HDMI connection, you can use the **Audio** port instead to play sound. Connect one end of an optional 3.5 mm stereo mini-jack audio cable to the projector's **Audio** port and the other end to your computer's audio out port. Then select **Audio** as the **HDMI Audio Output** setting in the Extended menu.

Parent topic: [Connecting to Video Sources](#)

Connecting to an MHL-Compatible Device

If you have an MHL-compatible smartphone or tablet, you can connect it to the projector using either an MHL cable or an HDMI cable with a device-compatible MHL adapter. If you have a device with a built-in MHL connector, plug it directly into the **HDMI2/MHL** port.

Note: Some connected devices may not charge when using an MHL adapter.

1. Connect the MHL cable or adapter to your device's Micro-USB port.
2. If you are using an MHL adapter, connect it to an MHL-compatible HDMI cable.

3. Connect the other end of the cable to the projector's **HDMI2/MHL** port.

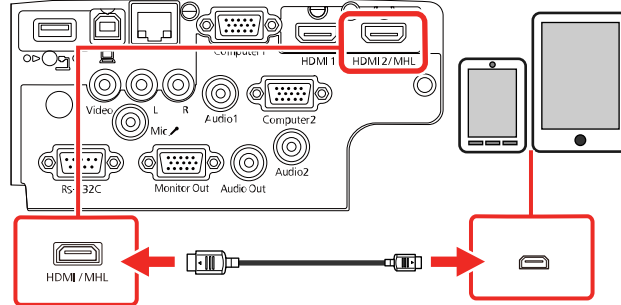

Note: The projector converts the digital audio signal sent from your video source into a mono analog signal for the internal speaker or a stereo analog signal if you are connecting to external speakers.

Parent topic: [Connecting to Video Sources](#)

Connecting to a Component Video Source

If your video source has component video ports, you can connect it to the projector using an optional component-to-VGA video cable. Depending on your component ports, you may need to use an adapter cable along with a component video cable.

1. Connect the component connectors to your video source's color-coded component video output ports, usually labeled **Y, Pb, Pr** or **Y, Cb, Cr**. If you are using an adapter, connect these connectors to your component video cable.
2. Connect the VGA connector to a **Computer** port on the projector.

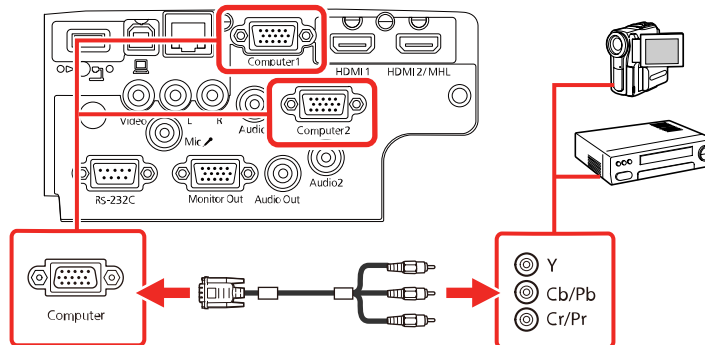

3. Tighten the screws on the VGA connector.

If your image colors appear incorrect, you may need to change the **Input Signal** setting in the projector's Signal menu.

Parent topic: [Connecting to Video Sources](#)

Related references

[Input Signal Settings - Signal Menu](#)

Related tasks

[Connecting to a Video Source for Sound](#)

Connecting to a Composite Video Source

If your video source has a composite video port, you can connect it to the projector using an optional RCA-style video or A/V cable.

1. Connect the cable with the yellow connector to your video source's yellow video output port.
2. Connect the other end to the projector's **Video** port.

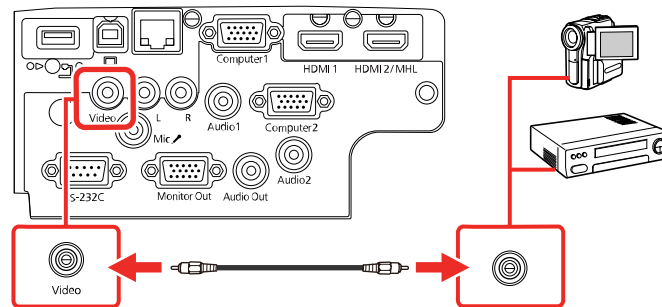

Parent topic: [Connecting to Video Sources](#)

Related tasks

[Connecting to a Video Source for Sound](#)

Connecting to a Video Source for Sound

You can play sound through the projector's speaker system if your video source has audio output ports. Connect the projector to the video source using an RCA audio cable.

Note: If you connected your video source to the projector using an HDMI or MHL cable, the audio signal is transferred with the video signal; you do not need an additional cable for sound.

1. Connect the audio cable to your video source's audio-out ports.
2. Connect the other end of the cable to the projector's **Audio** port or ports.

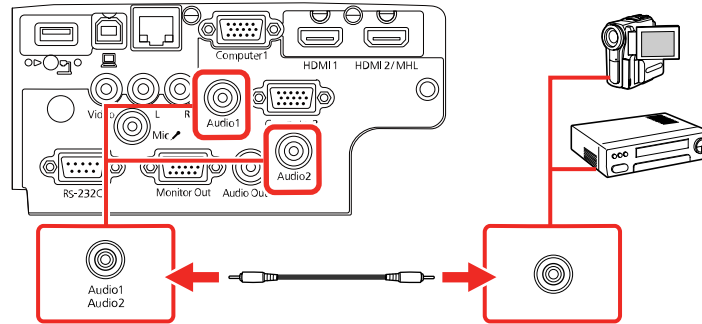

Parent topic: [Connecting to Video Sources](#)

Connecting External Output Devices

See these sections to connect the projector to external output devices.

[Connecting to an External Computer Monitor](#)

[Connecting to External Speakers](#)

[Connecting a Microphone](#)

Parent topic: [Projector Connections](#)

Connecting to an External Computer Monitor

If you connected a computer to the projector's **Computer** port, you can also connect an external monitor to the projector. This lets you see your presentation on the external monitor even when the projected image is not visible.

If you want to output images to an external monitor when the projector is turned off, you need to select **Always On** as the **A/V Output** setting in the projector's Extended menu.

Note: Monitors that use a refresh rate less than 60 Hz may not be able to display images correctly.

1. Make sure your computer is connected to the projector's **Computer** port. If there are two computer ports, make sure you use the **Computer1** port.

2. Connect the external monitor's cable to your projector's **Monitor Out** port.

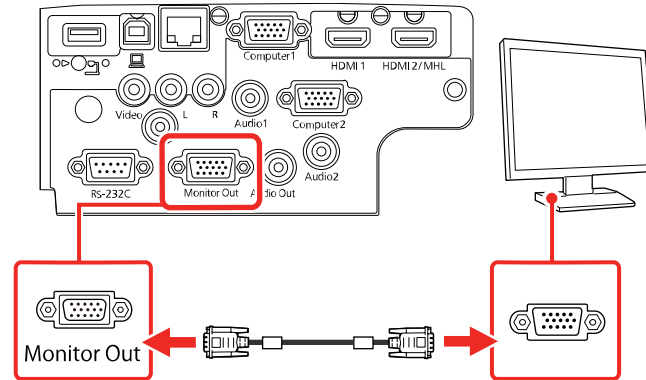

Parent topic: [Connecting External Output Devices](#)

Related references

[Projector Setup Settings - Extended Menu](#)

Connecting to External Speakers

To enhance the sound from your presentation, you can connect the projector to external self-powered speakers. You can control the volume using the projector's remote control.

You can also connect the projector to an amplifier with speakers.

If you want to output audio from the external speakers when the projector is turned off, you need to select **Always On** as the **A/V Output** setting in the projector's Extended menu.

Note: The projector's built-in speaker system is disabled when you connect external speakers.

1. Make sure your computer or video source is connected to the projector with both audio and video cables as necessary.
2. Locate the appropriate cable to connect your external speakers, such as a stereo mini-jack-to-pin-jack cable, or another type of cable or adapter.
3. Connect one end of the cable to your external speakers as necessary.

4. Connect the stereo mini-jack end of the cable to your projector's **Audio Out** port.

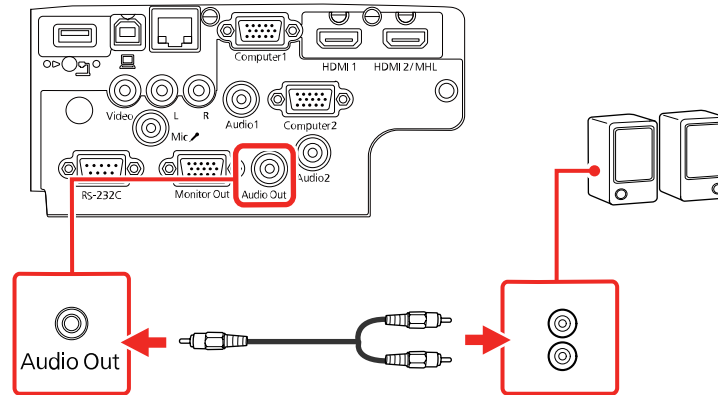

Parent topic: [Connecting External Output Devices](#)

Related references

[Projector Setup Settings - Extended Menu](#)

Connecting a Microphone

You can connect a microphone to the projector's **Mic** port to provide audio support during presentations.

Note: If you want to output audio from the microphone when the projector is off, select **Always On** as the **A/V Output** setting in the Extended menu.

1. Connect the microphone cable to the projector's **Mic** port.

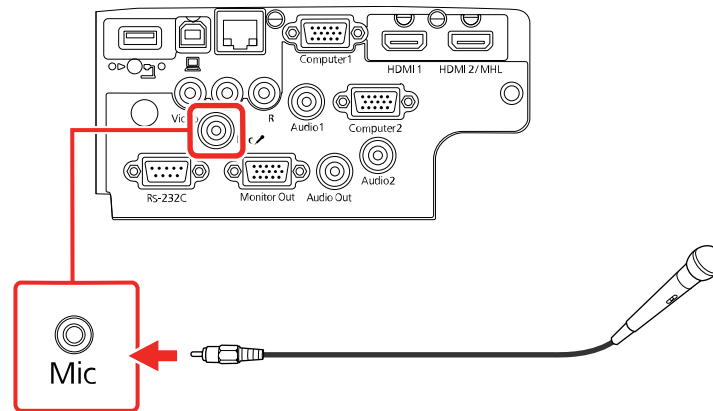

2. Turn on the microphone, if necessary.
3. **Parent topic:** [Connecting External Output Devices](#)

Connecting to External USB Devices

Follow the instructions in these sections to connect external USB devices to the projector.

[USB Device Projection](#)

[Connecting a USB Device or Camera to the Projector](#)

[Selecting the Connected USB Source](#)

[Disconnecting a USB Device or Camera From the Projector](#)

Parent topic: [Projector Connections](#)

Related topics

[Projecting a PC Free Presentation](#)

USB Device Projection

You can project images and other content without using a computer or video device by connecting any of these devices to your projector:

- USB flash drive
- Digital camera or smartphone
- USB hard drive

- Multimedia storage viewer

Note: Digital cameras or smartphones must be USB-mounted devices, not TWAIN-compliant devices, and must be USB Mass Storage Class-compliant.

Note: USB hard drives must meet these requirements:

- USB Mass Storage Class-compliant (not all USB Mass Storage Class devices are supported)
- Formatted in FAT or FAT32
- Self-powered by their own AC power supplies (bus-powered hard drives are not recommended)
- Does not have multiple partitions

You can project slide shows from image files on a connected USB device.

Parent topic: [Connecting to External USB Devices](#)

Connecting a USB Device or Camera to the Projector

You can connect your USB device or camera to the projector's **USB-A** port and use it to project images and other content.

1. If your USB device came with a power adapter, plug the device into an electrical outlet.
2. Connect the USB cable (or USB flash drive) to the projector's **USB-A** port.

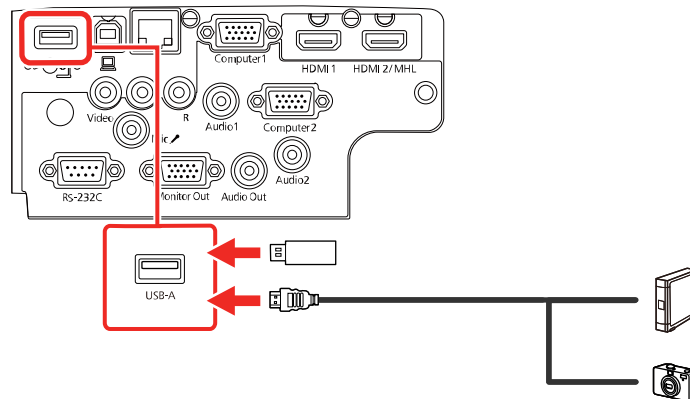

Note: Do not connect a USB hub or a USB cable longer than 10 feet (3 m), or the device may not operate correctly.

3. Connect the other end of the cable (if applicable) to your device.

Parent topic: [Connecting to External USB Devices](#)

Selecting the Connected USB Source

You can switch the projector's display to the source you connected to the **USB-A** port.

1. Make sure the connected USB source is turned on, if necessary.
2. Press the **USB** button on the remote control.

Parent topic: [Connecting to External USB Devices](#)

Disconnecting a USB Device or Camera From the Projector

When you finish presenting with a connected USB device or camera, you must prepare to disconnect the device from the projector.

1. If the device has a power button, turn off and unplug the device.
2. Disconnect the USB device or camera from the projector.

Parent topic: [Connecting to External USB Devices](#)

Connecting to a Document Camera

You can connect a document camera to your projector to project images viewed by the camera.

Depending on your Epson document camera model, do one of the following to connect the document camera to your projector:

- For the Epson DC-07 document camera, locate the USB cable that came with the camera and connect it to the projector's **USB-A** port and to the document camera's USB Type B port.
- For the Epson DC-13 document camera, connect it to the projector's **HDMI**, **Computer**, or **Video** port and to the corresponding port on the document camera. See the document camera manual for details.

- For the Epson DC-21 document camera, connect it to the projector's **HDMI**, **Computer**, or **Video** port and to the corresponding port on the document camera. See the document camera manual for details.

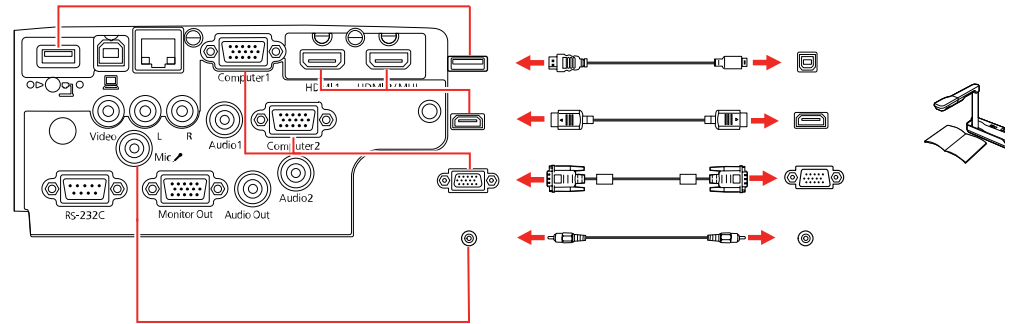

Note: For additional features supported by software, connect your document camera to your computer instead of the projector. See the document camera manual for details.

Parent topic: [Projector Connections](#)

Installing Batteries in the Remote Control

The remote control uses the two AA batteries that came with the projector.

Caution: Use only the type of batteries specified in this manual. Do not install batteries of different types, or mix new and old batteries.

1. Remove the battery cover.

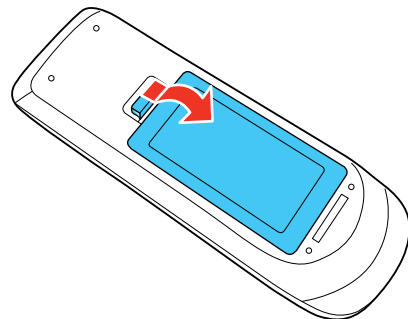

2. Insert the batteries with the + and – ends facing as shown.

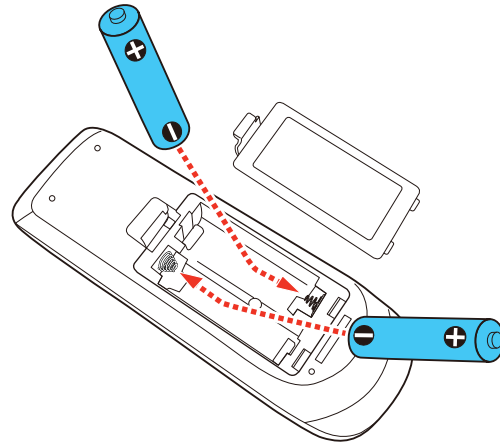

3. Replace the battery cover and press it down until it clicks into place.

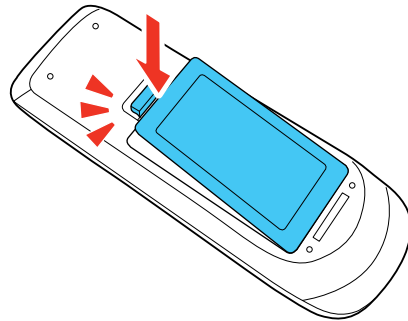

Warning: Dispose of used batteries according to local regulations. Do not expose batteries to heat or flame. Keep batteries out of the reach of children; they are choking hazards and are very dangerous if swallowed.

Parent topic: [Setting Up the Projector](#)

Opening the Lens Cover

To open the projector's lens cover, slide the **AV Mute** slide lever until it clicks into the open position.

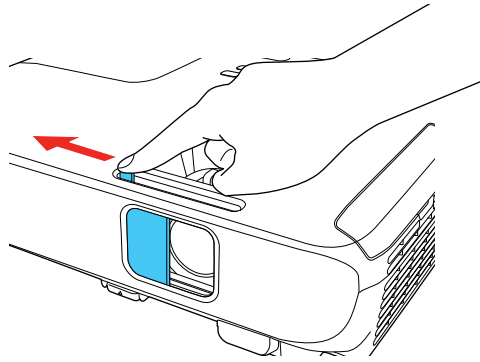

Parent topic: [Setting Up the Projector](#)

Using the Projector on a Network

Follow the instructions in these sections to set up your projector for use on a network.

[Wired Network Projection](#)

[Wireless Network Projection](#)

[Setting Up Projector Network E-Mail Alerts](#)

[Setting Up Monitoring Using SNMP](#)

[Controlling a Networked Projector Using a Web Browser](#)

Wired Network Projection

You can project through a wired network. To do this, you connect the projector to your network with an Ethernet cable, and then set up your projector and computer for network projection.

After connecting and setting up the projector as described here, install the network software from the included CD or download the software and manuals as necessary.

Note: If your projector is connected via a LAN (Ethernet) cable to a network that includes a wireless access point, you can connect to the projector wirelessly through the access point using the Epson network software.

[Connecting to a Wired Network](#)

[Selecting Wired Network Settings](#)

Parent topic: [Using the Projector on a Network](#)

Related references

[Additional Projector Software and Manuals](#)

Connecting to a Wired Network

To connect the projector to a wired local area network (LAN), use a 100Base-TX or 10Base-T network cable. To ensure proper data transmission, use a Category 5 shielded cable or better.

1. Connect one end of the network cable to your network hub, switch, or router.

2. Connect the other end of the cable to the projector's **LAN** port.

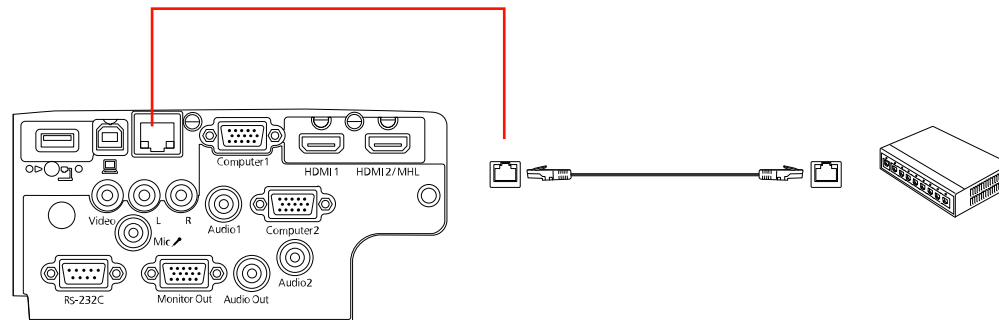

Parent topic: [Wired Network Projection](#)

Selecting Wired Network Settings

Before you can project from computers on your network, you must select the network settings for the projector using its menu system.

Note: Make sure you already connected the projector to your wired network using the **LAN** port.

1. Turn on the projector.
2. Press the **Menu** button.

3. Select the **Network** menu and press **Enter**.

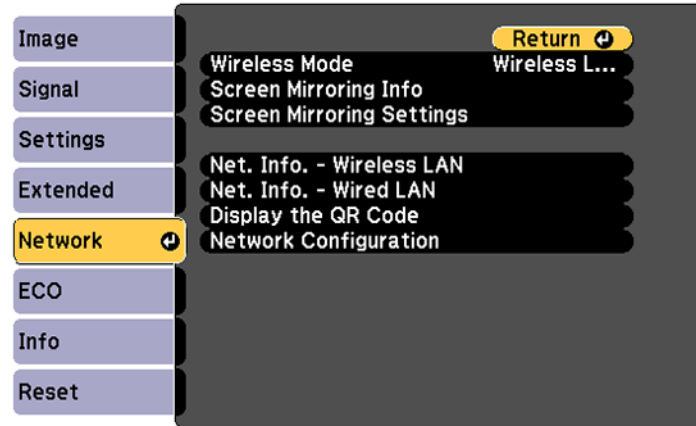

4. Select **Network Configuration** and press **Enter**.
5. Select the **Basic** menu and press **Enter**.

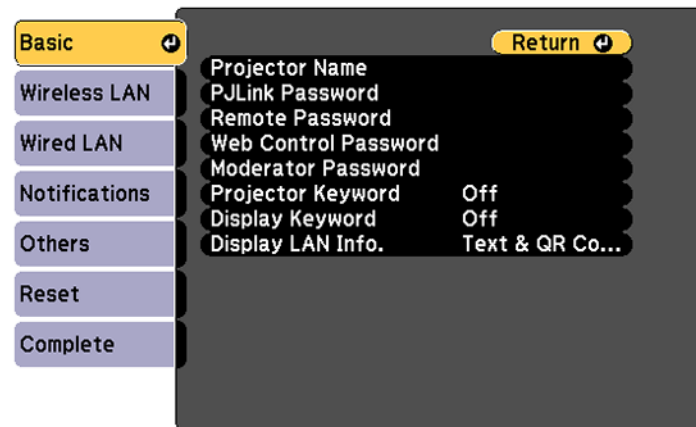

6. Select the following basic options as necessary:
 - **Projector Name** lets you enter a name up to 16 alphanumeric characters long to identify the projector over the network.

- **PJLink Password** lets you enter a password up to 32 alphanumeric characters long for using the PJLink protocol for projector control.
- **Remote Password** lets you enter a password up to 8 alphanumeric characters long for accessing the Remote or Basic Control screen in Epson Web Control. (Default user name is **EPSONREMOTE**; default password is **guest**.)
- **Web Control Password** lets you enter a password up to 8 alphanumeric characters long for accessing the projector over the web. (Default user name is **EPSONWEB**; default password is **admin**.)
- **Moderator Password** lets you enter a password up to 4 numbers long for accessing the projector as a moderator with Epson iProjection (Windows/Mac) software or the Epson iProjection app. (No default password.)
- **Projector Keyword** lets you turn on a security password to prevent access to the projector by anyone not in the room with it. You must enter a displayed, randomized keyword from a computer using the Epson iProjection software to access the projector.
- **Display Keyword** lets you select whether or not to display a projector keyword on the projected image when using the Epson iProjection software to access the projector.
- **Display LAN Info** lets you select how the projector displays network information. You can select an option to display a QR code that lets you quickly connect your iOS or Android devices using the Epson iProjection app.

Note: Use the displayed keyboard to enter the name, passwords, and keyword. Press the arrow buttons on the remote control to highlight characters and press **Enter** to select them.

7. Select the **Wired LAN** menu and press **Enter**.

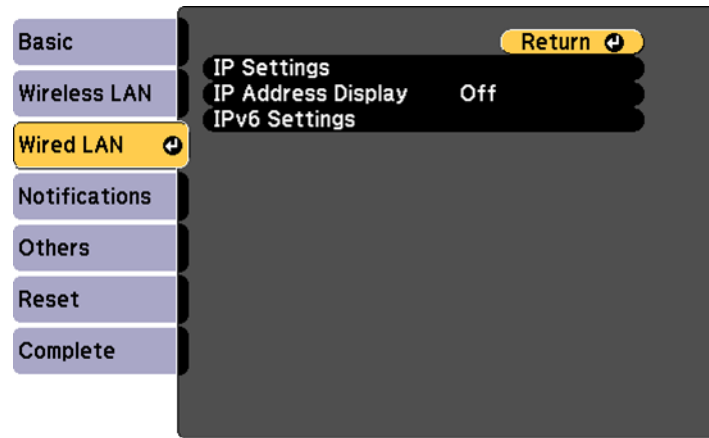

8. If necessary, select **IP Settings** and press **Enter**.
9. Select your IP Settings as necessary:
 - If your network assigns addresses automatically, turn on the **DHCP** setting.
 - If you must set addresses manually, turn off **DHCP** and enter the projector's **IP Address**, **Subnet Mask**, and **Gateway Address** as needed.

Note: To highlight the numbers you want from the displayed keyboard, press the arrow buttons on the remote control. To select a highlighted number, press **Enter**. Or, press and hold the **Num** button on the remote control while entering the desired numbers.

10. To prevent display of the IP address on the standby screen, turn off **IP Address Display**.
11. When you finish selecting settings, select **Complete** and follow the on-screen instructions to save your settings and exit the menus.

Parent topic: [Wired Network Projection](#)

Wireless Network Projection

You can project over a wireless network. To do this, you must set up your projector and computer for wireless projection.

After setting up the projector as described here, install the network software from the included CD or download the software and manuals as necessary. After setting up the projector as described here, download the network software and manuals as necessary.

Note: If your projector is connected via a LAN cable to a network that includes a wireless access point, you can connect to the projector wirelessly through the access point using the Epson network software.

[Installing the Wireless LAN Module](#)

[Using a QR Code to Connect a Mobile Device](#)

[Using Quick Wireless Connection \(Windows\)](#)

[Selecting Wireless Network Settings Manually](#)

[Selecting Wireless Network Settings in Windows](#)

[Selecting Wireless Network Settings on Mac](#)

[Setting Up Wireless Network Security](#)

Parent topic: [Using the Projector on a Network](#)

Related references

[Additional Projector Software and Manuals](#)

[Optional Equipment and Replacement Parts](#)

Installing the Wireless LAN Module

To use the projector over a wireless network, install the Epson 802.11b/g/n wireless LAN module in the projector. Do not install any other type of wireless module.

Note: The wireless LAN module is not included with your projector and is optional.

1. Remove the wireless LAN module cover screw.

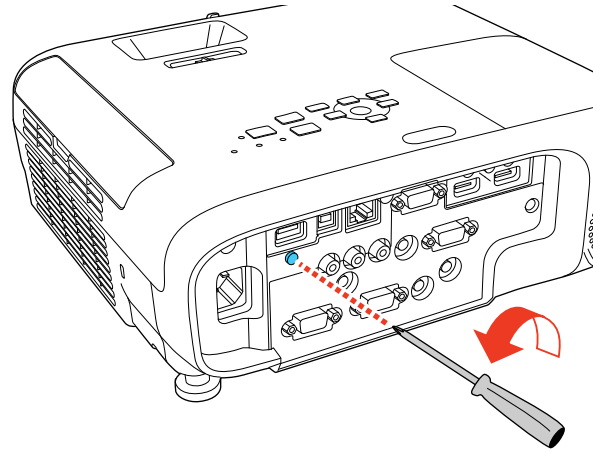

2. Insert the wireless LAN module into the **USB-A** port.

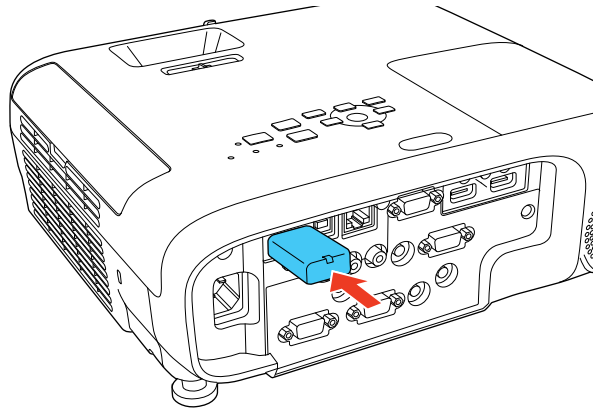

3. Attach the wireless LAN module cover and secure it using the screw you removed.

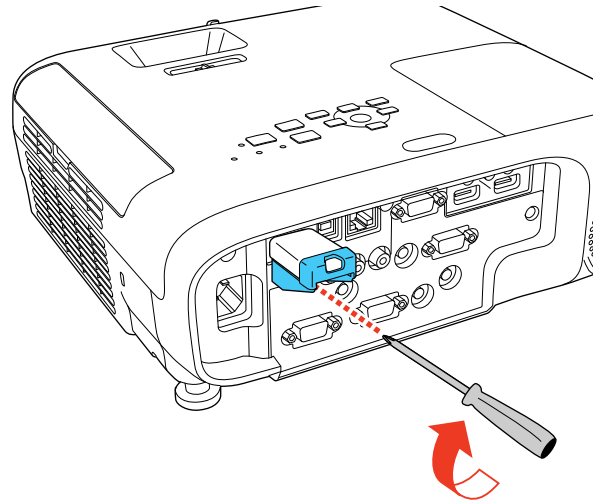

The light on the wireless LAN module turns on when the module is installed and operating. The light flashes when the module is communicating over the network.

Parent topic: [Wireless Network Projection](#)

Related references

[Optional Equipment and Replacement Parts](#)

Using a QR Code to Connect a Mobile Device

After you select the wireless network settings for your projector, you can display a QR code on the screen and use it to connect a mobile device using the Epson iProjection app.

Note: Make sure you have installed the latest version of Epson iProjection on your device. Visit epson.com/iprojection (U.S.) or epson.ca/iprojection (Canada) for more information.

1. Press the **Menu** button.

2. Select the **Network** menu and press **Enter**.

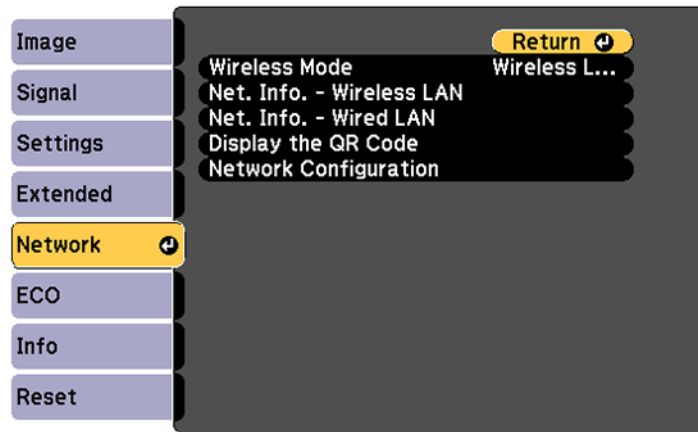

3. Select **Network Configuration** and press **Enter**.
4. Select the **Basic** menu and press **Enter**.

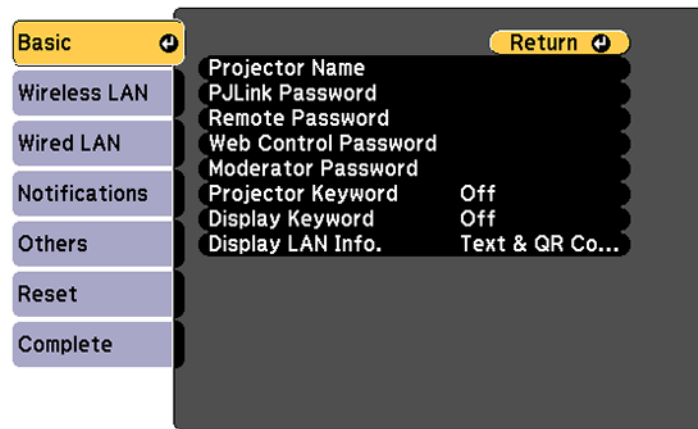

5. Set the **Display LAN Info** setting to **Text & QR Code**.
6. Select **Complete** and follow the on-screen instructions to save your settings and exit the menus.

7. Do one of the following:
 - Press the **LAN** button on the remote control.
 - Select **Display the QR Code** in the projector's Network menu.

Your projector displays the QR code on the projection surface.

Note: If you do not see the QR code after pressing the **LAN** button, press **Enter** to display it.

8. Start Epson iProjection on your mobile device.
9. Use the QR code reader feature to read the QR code and connect your device to the projector. Visit epson.com/iprojection (U.S.) or epson.ca/iprojection (Canada) for instructions.

Parent topic: [Wireless Network Projection](#)

Using Quick Wireless Connection (Windows)

You can create a Quick Wireless Connection USB Key to quickly connect the projector to a Windows computer wirelessly. Then you can project your presentation and remove the key when you are done.

Note: A USB flash drive is not included with your projector.

1. Create a Quick Wireless Connection USB Key with a USB flash drive and the Epson iProjection (Windows/Mac) software.

Note: See the online *Epson iProjection Operation Guide* for instructions.

2. Turn on the projector.
3. Remove the wireless LAN module from the **USB-A** port.

4. Insert the USB key into the projector's **USB-A** port.

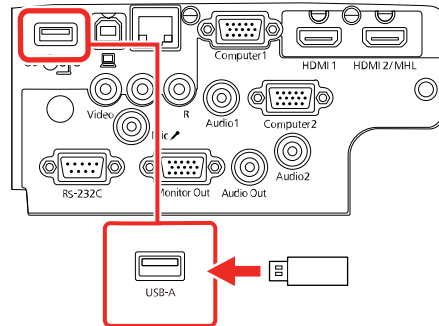

You see a projected message that the network information update is complete.

5. Remove the USB key.
6. Reinsert the wireless LAN module into the projector.
7. Insert the USB key into a USB port on your computer.

Note: In Windows Vista, if you see the AutoPlay window, select **Run MPPLaunch.exe**, then select **Allow** on the next screen.

8. Follow the on-screen instructions to install the Epson iProjection (Windows/Mac) software.

Note: If you see a Windows Firewall message, click **Yes** to disable the firewall. You need administrator authority to install the software. If it is not installed automatically, double-click **MPPLaunch.exe** in the USB key.

After a few minutes, your computer image is displayed by the projector. If it does not appear, press the **LAN** or **Source Search** button on your remote control or restart your computer.

9. Run your presentation as necessary.
10. When you finish projecting wirelessly, select the **Safely Remove Hardware** option in the Windows taskbar, then remove the USB key from your computer.

Note: You can share the USB key with other computers without disconnecting your computer. You may need to restart your computer to reactivate your wireless LAN connection.

Parent topic: [Wireless Network Projection](#)

Related references

[Additional Projector Software and Manuals](#)

Selecting Wireless Network Settings Manually

Before you can project from your wireless network, you must select the network settings for the projector using its menu system.

1. Turn on the projector.
2. Press the **Menu** button.
3. Select the **Network** menu and press **Enter**.

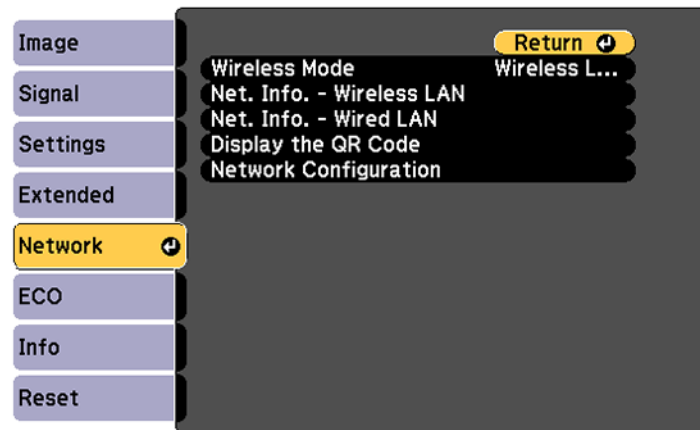

4. Make sure the **Wireless Mode** setting is set to **Wireless LAN On**.
5. Select **Network Configuration** and press **Enter**.

6. Select the **Basic** menu and press **Enter**.

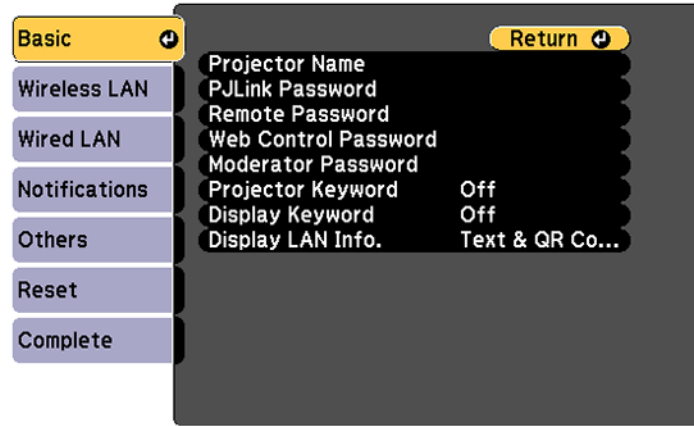

7. Select the following basic options as necessary:

- **Projector Name** lets you enter a name up to 16 alphanumeric characters long to identify the projector over the network.
- **PJLink Password** lets you enter a password up to 32 alphanumeric characters long for using the PJLink protocol for projector control.
- **Remote Password** lets you enter a password up to 8 alphanumeric characters long for accessing the Remote or Basic Control screen in the Epson Web Control. (Default user name is **EPSONREMOTE**; default password is **guest**.)
- **Web Control Password** lets you enter a password up to 8 alphanumeric characters long for accessing the projector over the web. (Default user name is **EPSONWEB**; default password is **admin**.)
- **Moderator Password** lets you enter a password up to 4 numbers long for accessing the projector as a moderator with Epson iProjection software or the Epson iProjection app.
- **Projector Keyword** lets you turn on a security password to prevent access to the projector by anyone not in the room with it. The projector displays a random keyword that you must enter from a computer using the Epson iProjection software or an iOS or Android device using the Epson iProjection app.
- **Display Keyword** lets you display a keyword on the projected image when accessing the projector from a computer using the Epson iProjection software or an iOS or Android device using the Epson iProjection app.

- **Display LAN Info** lets you select how the projector displays network information. You can select an option to display a QR code that lets you quickly connect your iOS or Android devices with the Epson iProjection app.

Note: Use the displayed keyboard to enter the name, passwords and keyword. Press the arrow buttons on the remote control to highlight characters and press **Enter** to select them.

8. Select the **Wireless LAN** menu and press **Enter**.

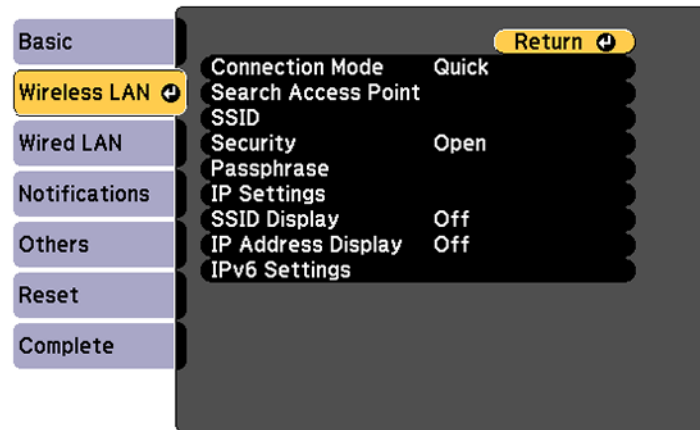

9. Select the settings on the **Wireless LAN** menu as necessary for your network.
10. When you finish selecting settings, select **Complete** and follow the on-screen instructions to save your settings and exit the menus.

After you complete the wireless settings for your projector, you need to select the wireless network on your computer, or iOS or Android device.

[Wireless LAN Menu Settings](#)

Parent topic: [Wireless Network Projection](#)

Wireless LAN Menu Settings

Setting	Options	Description
Connection Mode	Quick Advanced	Selects the type of wireless connection: Quick: lets you directly connect to multiple devices and computers using the projector's wireless network; requires the optional wireless LAN module Advanced: lets you connect to multiple smartphones, tablets, or computers via a wireless network access point
Search Access Point	To Search View	Search for available wireless network access points in Advanced connection mode
SSID	Up 32 alphanumeric characters	Sets the SSID (network name) of the wireless LAN system the projector is connecting to
Security	Open WPA2-PSK WPA/WPA2-PSK	Selects the type of wireless security used in the wireless network (some options are only available when the Connection Mode setting is set to Advanced)
Passphrase	Between 8 to 63 alphanumeric characters	Enter a paraphrase for the wireless network
Channel	1ch 6ch 11ch	In Quick connection mode, selects the frequency band (channel) used by the wireless LAN

Setting	Options	Description
IP Settings	DHCP IP Address Subnet Mask Gateway Address	Turns on DHCP if your network assigns addresses automatically; set to Off to manually enter the network's IP Address , Subnet Mask , and Gateway Address
SSID Display	On Off	Selects whether to display the SSID on the network standby screen and the Home screen
IP Address Display	On Off	Selects whether to display the IP address on the network standby screen and the Home screen
IPv6 Settings	IPv6 Auto Configuration Use Temporary Address	Selects the IPv6 settings when you connect the projector to the network using IPv6

Parent topic: [Selecting Wireless Network Settings Manually](#)

Selecting Wireless Network Settings in Windows

Before connecting to the projector, select the correct wireless network on your computer.

1. To access your wireless utility software, access the Desktop and double-click the network icon on the Windows taskbar.
2. Do one of the following:
 - If your projector is set up on an existing network (Advanced mode), select the network name (SSID).
 - If your projector is configured for Quick mode, select the projector's SSID.
3. Click **Connect**.

Parent topic: [Wireless Network Projection](#)

Selecting Wireless Network Settings on Mac

Before connecting to the projector, select the correct wireless network on your Mac.

1. Click the AirPort icon on the menu bar at the top of the screen.

2. Make sure AirPort is turned on, then do one of the following:
 - If your projector is set up on an existing network (Advanced mode), select the network name (SSID).
 - If your projector is configured for Quick mode, select the projector's SSID.

Parent topic: [Wireless Network Projection](#)

Setting Up Wireless Network Security

You can set up security for your projector to use on the wireless network. Set up one of the following security options to match the settings used on your network:

- WPA/WPA2-PSK security (Advanced connection mode)
- WPA2-PSK security (Advanced and Quick connection mode)

Check with your network administrator for guidance on entering the correct information.

1. Press the **Menu** button.
2. Select the **Network** menu and press **Enter**.
3. Select **Network Configuration** and press **Enter**.
4. Select the **Wireless LAN** menu and press **Enter**.

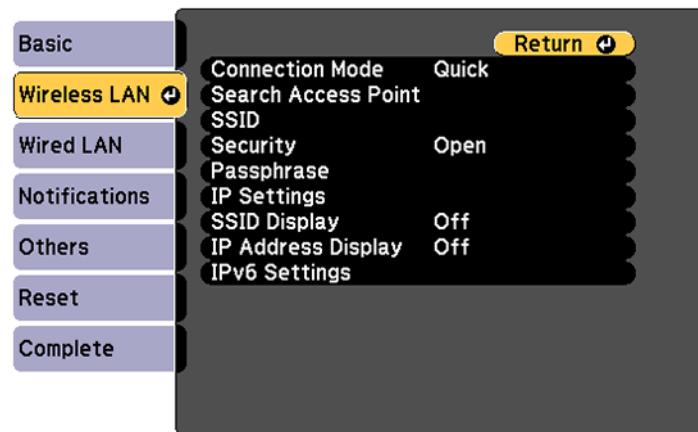

5. Select the **Security** setting and press **Enter**.
6. Select the security settings for your network.

- When you finish selecting settings, select **Complete** and follow the on-screen instructions to save your settings and exit the menus.

Parent topic: [Wireless Network Projection](#)

Setting Up Projector Network E-Mail Alerts

You can set up the projector to send you an e-mail alert over the network if there is a problem with the projector.

- Press the **Menu** button.
- Select the **Network** menu and press **Enter**.
- Select **Network Configuration** and press **Enter**.
- Select the **Notifications** menu and press **Enter**.

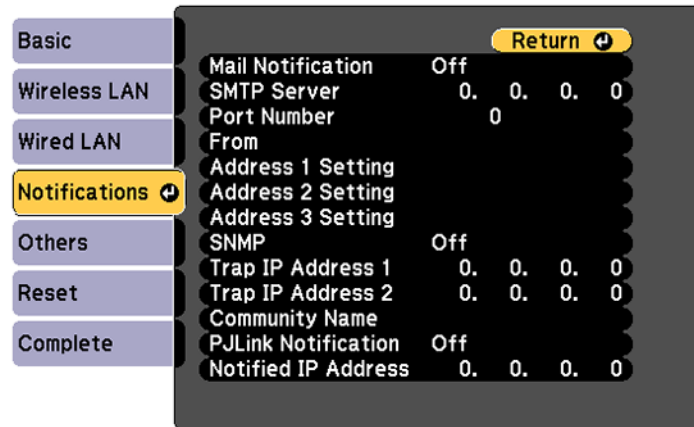

- Turn on **Mail Notification**.
- Enter the IP address for the **SMTP Server** setting.

Note: To enter the IP address using the numeric keys on the remote control, press and hold the **Num** button. Do not use these addresses: 127.x.x.x or 224.0.0.0 through 255.255.255.255 (where x is a number from 0 to 255).

- Select a number for the SMTP server **Port Number** setting, from 1 to 65535 (default is 25).

8. Enter the sender's email address as the **From** setting.
9. Choose an **Address** field, enter the e-mail address, and select the alerts you want to receive there. Repeat for up to three addresses. Your e-mail address can be up to 32 alphanumeric characters long.
10. When you finish selecting settings, select **Complete** and follow the on-screen instructions to save your settings and exit the menus.

Note: If a critical problem causes a projector to shut down, you may not receive an e-mail alert.

[Network Projector E-mail Alert Messages](#)

Parent topic: [Using the Projector on a Network](#)

Network Projector E-mail Alert Messages

When a problem occurs with a networked projector, and you selected to receive e-mail alerts, you receive an e-mail containing the following information:

- The email address entered as the **From** setting
- **Epson Projector** on the subject line
- The name of the projector experiencing a problem
- The IP address of the affected projector
- Detailed information about the problem

Note: If a critical problem causes a projector to shut down, you may not receive an e-mail alert.

Parent topic: [Setting Up Projector Network E-Mail Alerts](#)

Setting Up Monitoring Using SNMP

Network administrators can install SNMP (Simple Network Management Protocol) software on network computers so they can monitor projectors. If your network uses this software, you can set up the projector for SNMP monitoring.

1. Press the **Menu** button.
2. Select the **Network** menu and press **Enter**.
3. Select **Network Configuration** and press **Enter**.

4. Select the **Notifications** menu and press **Enter**.

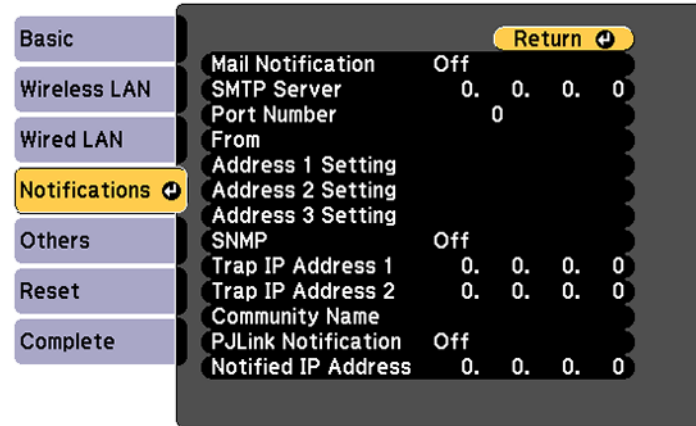

5. Turn on the **SNMP** setting.
6. Enter up to two IP addresses to receive SNMP notifications, using 0 to 255 for each address field.

Note: To enter the IP address using the numeric keys on the remote control, press and hold the **Num** button. Do not use these addresses: 127.x.x.x or 224.0.0.0 through 255.255.255.255 (where x is a number from 0 to 255).

7. Enter a community name. You can enter up to 32 single-byte alphanumeric characters.
8. If you want this projector to receive broadcasted messages over the network, select the **Others** menu and turn on the **Message Broadcasting** setting. Administrators can broadcast messages over the network using Epson Projector Management (Windows only).
9. When you finish selecting settings, select **Complete** and follow the on-screen instructions to save your settings and exit the menus.

Parent topic: [Using the Projector on a Network](#)

Controlling a Networked Projector Using a Web Browser

Once you have connected your projector to your network, you can select projector settings and control projection using a compatible web browser. This lets you access the projector remotely.

Note: The web setup and control features support Microsoft Internet Explorer 9.0 or later, and Safari on networks that do not use a proxy server for connection. You cannot select all of the projector menu settings or control all projector functions using a web browser.

Note: If you set Standby Mode to **Communication On** in the ECO menu, you can use a web browser to select settings and control projection even if the projector is in standby mode.

1. Make sure the projector is turned on.
2. Start your web browser on a computer or device connected to the network.
3. Type the projector's IP address into the browser's address box and press the computer's **Enter** key.
You see the Web Control screen.

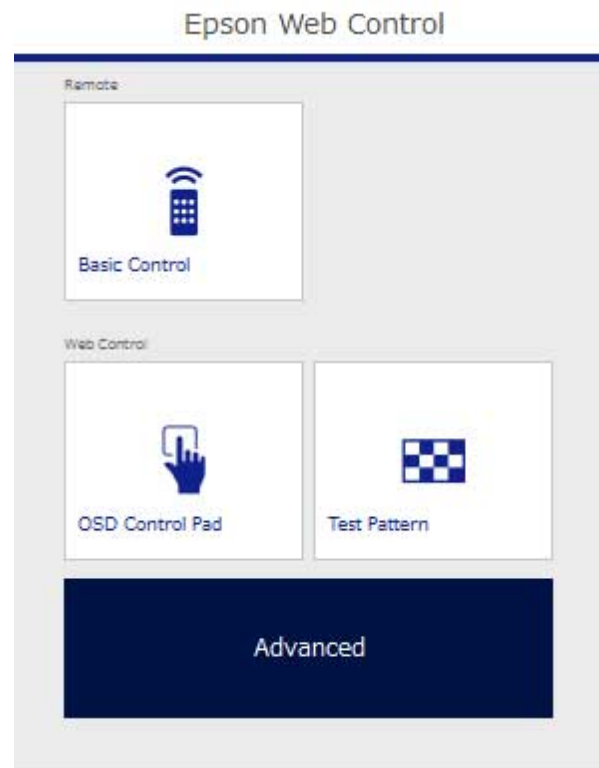

- To select projector menu settings, select **Advanced** to display a list of options.

Note: You may need to log in to access some of the options on the Web Control screen. If you see a log in window, enter your user name and password. (The default user name is **EPSONWEB** and the default password is **admin**.)

- To control projection remotely, select the **Basic Control** option from the Web Control screen.

Note: If you see a log in window, enter your user name and password. (The default user name is **EPSONREMOTE** and the default password is **guest**.)

You see a screen like this:

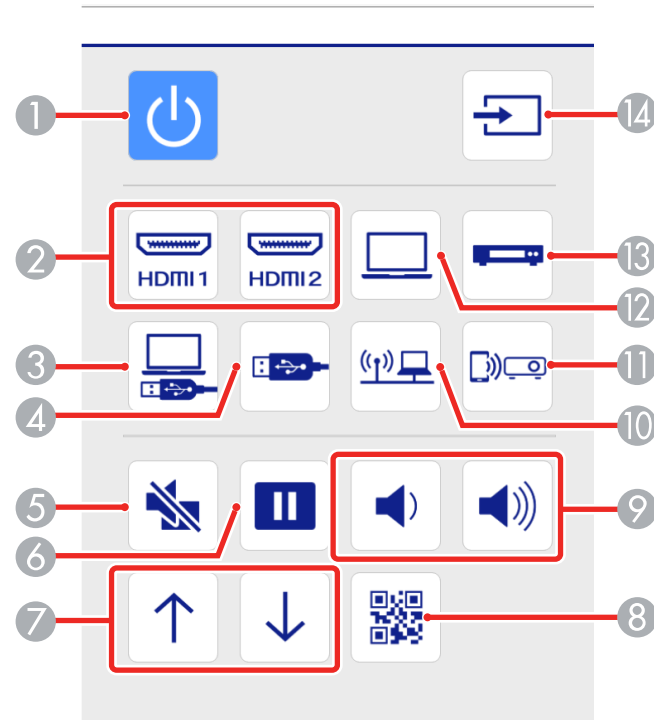

- Power button control

- 2 Select an **HDMI** port source
- 3 Selects the USB Display source
- 4 Selects the USB device source
- 5 **A/V Mute** button control
- 6 **Freeze** button control
- 7 **Page Up** and **Page Down** button controls
- 8 Displays a QR code
- 9 **Volume** button controls
- 10 Selects the network source
- 11 Selects the Screen Mirroring source
- 12 Selects the **Computer** port source
- 13 Selects a **Video** port source
- 14 Searches for connected sources

6. Select the icon corresponding to the projector function you want to control.

Parent topic: [Using the Projector on a Network](#)

Related references

[Projector Setup Settings - ECO Menu](#)

[Solutions When You Cannot Access the Projector Through the Web](#)

Using Basic Projector Features

Follow the instructions in these sections to use your projector's basic features.

[Turning On the Projector](#)

[Turning Off the Projector](#)

[Selecting the Language for the Projector Menus](#)

[Adjusting the Image Height](#)

[Image Shape](#)

[Resizing the Image with the Zoom Ring](#)

[Focusing the Image Using the Focus Ring](#)

[Remote Control Operation](#)

[Selecting an Image Source](#)

[Projection Modes](#)

[Image Aspect Ratio](#)

[Color Mode](#)

[Controlling the Volume with the Volume Buttons](#)

[Projecting a PC Free Presentation](#)

Turning On the Projector

Turn on the computer or video equipment you want to use before you turn on the projector so it can display the image source.

1. Connect the power cord to the projector's power inlet.

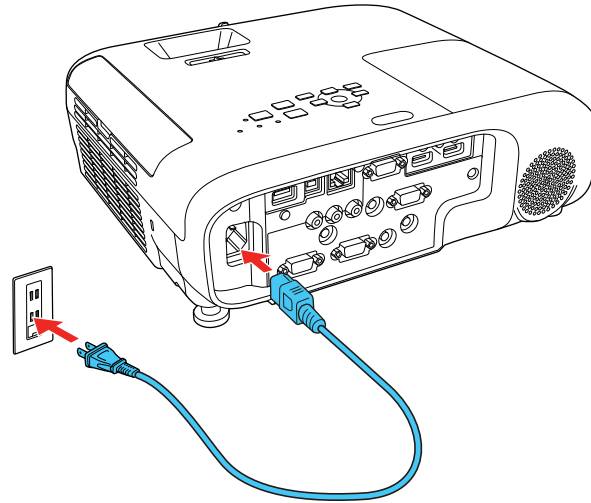

2. Plug the power cord into an electrical outlet.

Note: With **Direct Power On** turned on, the projector turns on as soon as you plug it in.

The projector's power light turns blue. This indicates that the projector is receiving power.

3. Press the power button on the projector or the remote control to turn on the projector.

The projector beeps and the Status light flashes blue as the projector warms up. Once the projector is warmed up, the light stops flashing and turns blue.

Warning: Never look into the projector lens when the lamp is on. This can damage your eyes and is especially dangerous for children.

If you do not see a projected image right away, try the following:

- Verify the lens cover is open all the way.
- Turn on the connected computer or video device.
- Insert a DVD or other video media and press the play button, if necessary.
- Change the screen output from the computer when using a laptop.

- Press the **Source Search** button on the projector or remote control to detect the video source.
- Press the button for the video source on the remote control.
- If the Home screen is displayed, select the source you want to project.

Using the Home Screen

Parent topic: [Using Basic Projector Features](#)

Related tasks

[Selecting an Image Source](#)

Using the Home Screen

You can select input sources and other frequently used options from the Home screen.

1. To display the Home screen, do one of the following:
 - Press the **Home** button on the remote control.
 - Turn on the projector with the **Home Screen Auto Disp** setting enabled.
 - Turn on the projector when no signal is received from the selected input source.
2. Press the arrow buttons on the remote control or control panel to navigate the screen, and press **Enter** to select an option.

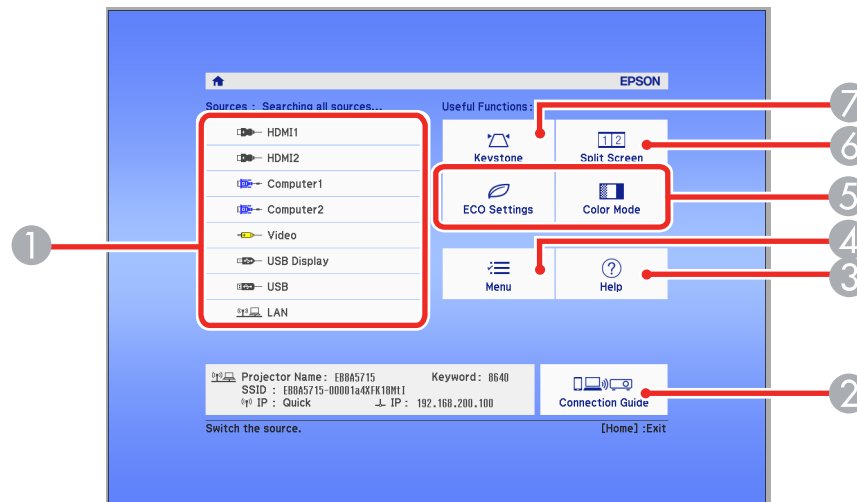

- 1 Select the video source you want to project
- 2 Display the Connection Guide
- 3 Display the Help screen
- 4 Display the projector's menus
- 5 Select customizable menu options
- 6 Select to project two images from different image sources simultaneously
- 7 Correct the image shape

Note: Your Home screen may look different from the illustration shown here. You can select the customizable menu options using the **Custom Function 1** and **Custom Function 2** settings in the Extended menu.

3. Press the **Home** button to hide the Home screen.

Parent topic: [Turning On the Projector](#)

Related references

[Projector Setup Settings - Extended Menu](#)

Turning Off the Projector

Before turning off the projector, shut down any computer connected to it so you can see the computer display during shutdown.

Note: Turn off this product when not in use to prolong the life of the projector. Lamp life will vary depending upon mode selected, environmental conditions, and usage. Brightness decreases over time.

Note: When using the A/V Mute feature, the projector lamp is still on. To turn off the lamp, turn off the projector.

1. Press the power button on the projector or the remote control.

The projector displays a shutdown confirmation screen.



2. Press the power button again. (To leave it on, press any other button.)
The projector beeps twice, the lamp turns off, and the Status light turns off.

Note: With Epson's Instant Off technology, there is no cool-down period so you can pack up the projector for transport right away (if necessary).

3. To transport or store the projector, make sure Status light is off, then unplug the power cord.

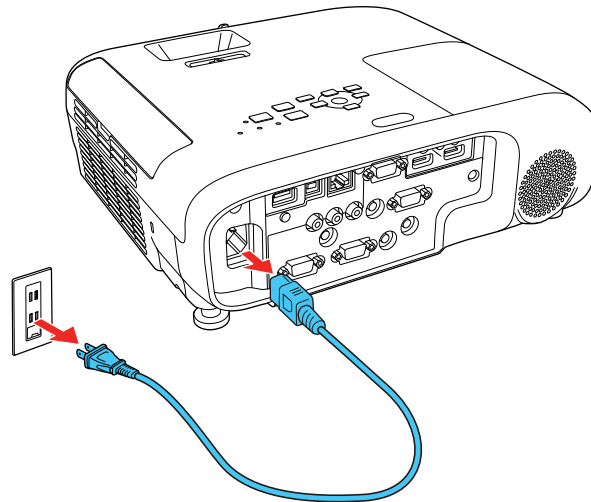

Caution: To avoid damaging the projector or lamp, never unplug the power cord when the Status light is on or flashing.

Parent topic: [Using Basic Projector Features](#)

Related references

[Projector Light Status](#)

Selecting the Language for the Projector Menus

If you want to view the projector's menus and messages in another language, you can change the Language setting.

1. Turn on the projector.
2. Press the **Menu** button.
3. Select the **Extended** menu and press **Enter**.

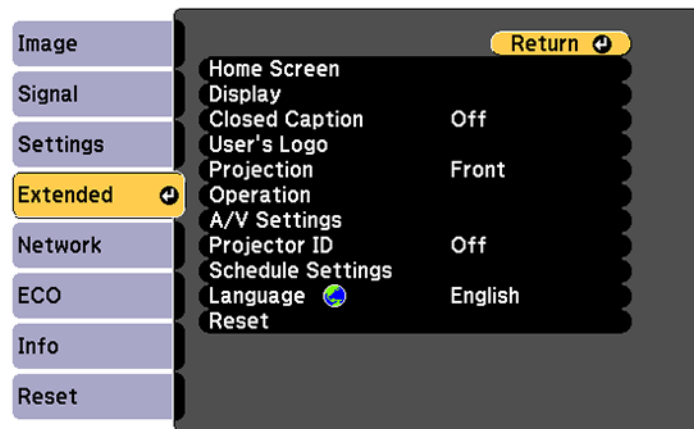

4. Select the **Language** setting and press **Enter**.
5. Select the language you want to use and press **Enter**.
6. Press **Menu** or **Esc** to exit the menus.

Parent topic: [Using Basic Projector Features](#)

Adjusting the Image Height

If you are projecting from a table or other flat surface, and the image is too high or low, you can adjust the image height using the projector's adjustable feet.

1. Turn on the projector and display an image.
2. To adjust the front foot, pull up on the foot release lever and lift the front of the projector.

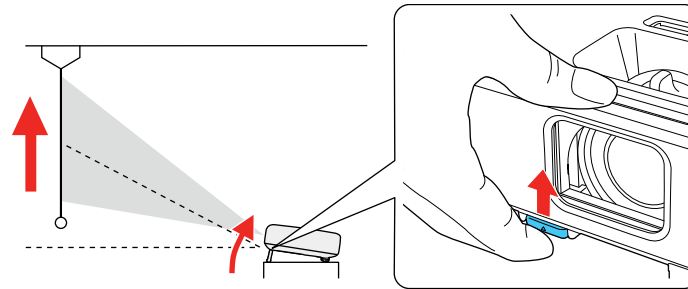

The foot extends from the projector.

3. Release the lever to lock the foot.
4. If the image is tilted, rotate the rear feet to adjust their height.

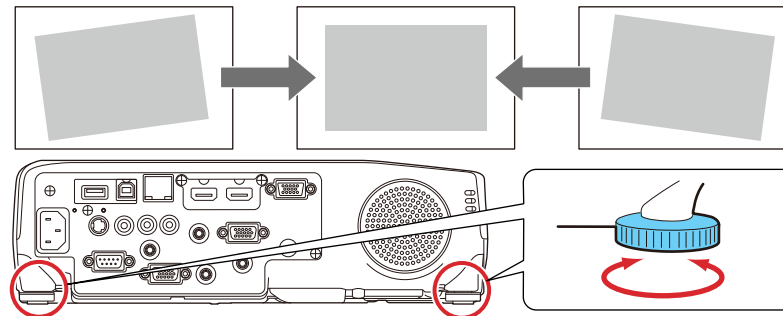

If the projected image is unevenly rectangular, you need to adjust the image shape.

Parent topic: [Using Basic Projector Features](#)

Image Shape

You can project an evenly rectangular image by placing the projector directly in front of the center of the screen and keeping it level. If you place the projector at an angle to the screen, or tilted up or down, or off to the side, you may need to correct the image shape for the best display quality.

When you turn on automatic keystone correction in your projector's Settings menu, your projector automatically corrects vertical keystone effects when you reposition the projector.

[Correcting Image Shape with the Horizontal Keystone Slider](#)

[Correcting Image Shape with the Keystone Buttons](#)

[Correcting Image Shape with Quick Corner](#)

Parent topic: [Using Basic Projector Features](#)

Correcting Image Shape with the Horizontal Keystone Slider

You can use the projector's horizontal keystone slider to correct the shape of an image that is unevenly rectangular horizontally, such as when the projector is placed to the side of the projection area.

Note: To provide the best possible image quality, adjust the projector's position to correct the image shape. If this isn't possible, use the horizontal keystone slider on the projector to correct the image shape.

1. Turn on the projector and display an image.

Note: You can display a pattern to aid in adjusting the projected image using the Settings menu.

2. Adjust the slider until the image is evenly rectangular.

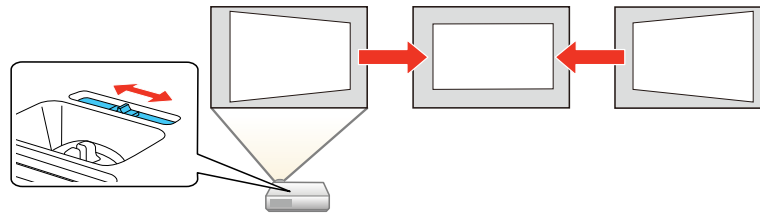

After correction, your image is slightly smaller.

Parent topic: [Image Shape](#)

Correcting Image Shape with the Keystone Buttons

You can use the projector's keystone correction buttons to correct the shape of an image that is unevenly rectangular on the sides.

Note: To provide the best possible image quality, adjust the projector's position to correct the image shape. If this isn't possible, use the keystone correction buttons on the projector to correct the image shape.

1. Turn on the projector and display an image.

Note: You can display a pattern to aid in adjusting the projected image using the Settings menu.

Note: You can also display the pattern by pressing the **User** button on the remote control (if the test pattern is assigned to this button).

2. Press one of these keystone buttons on the control panel to display the Keystone adjustment screen.

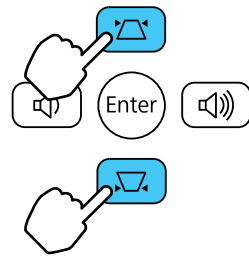

3. Press a keystone button on the projector's control panel to adjust the image shape.

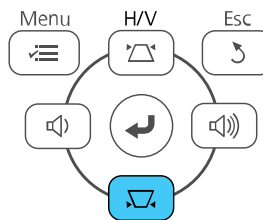
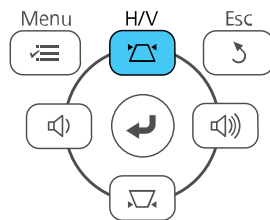
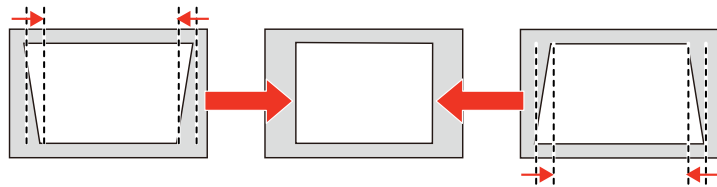
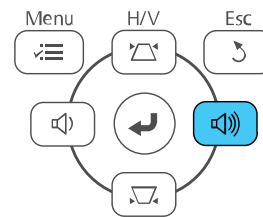
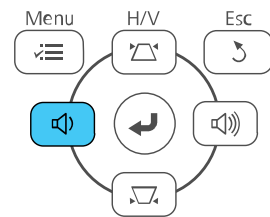
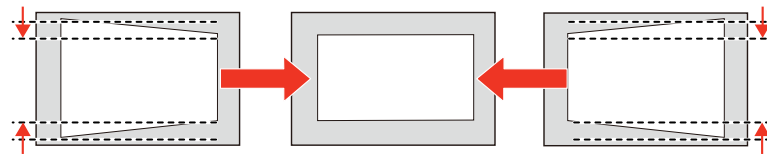

After correction, your image is slightly smaller.

Note: If the projector is installed out of reach, you can also correct the image shape with the remote control using the **H/V-Keystone** settings in the projector menus.

Parent topic: [Image Shape](#)

Related references

[Projector Feature Settings - Settings Menu](#)

Correcting Image Shape with Quick Corner

You can use the projector's Quick Corner setting to correct the shape and size of an image that is unevenly rectangular on all sides.

Note: To provide the best possible image quality, adjust the projector's position to correct the image shape. If this isn't possible, use the Quick Corner setting to correct the image shape.

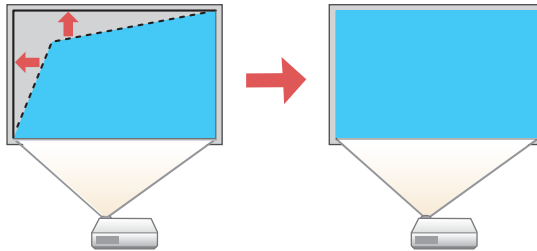

1. Turn on the projector and display an image.

Note: You can display a pattern to aid in adjusting the projected image using the Settings menu.

Note: You can also display the pattern by pressing the **User** button on the remote control (if the test pattern is assigned to this button).

2. Press the **Menu** button.

3. Select the **Settings** menu and press **Enter**.

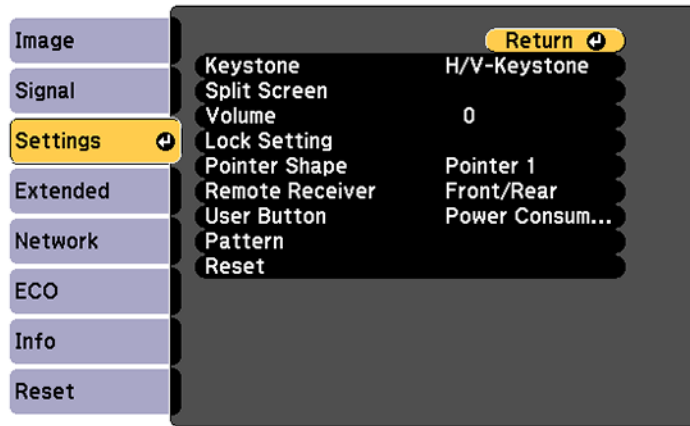

4. Select the **Keystone** setting and press **Enter**.
5. Select the **Quick Corner** setting and press **Enter**. Then press **Enter** again.
You see the Quick Corner adjustment screen:

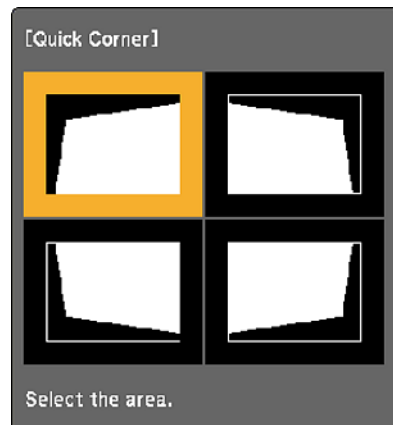

6. Use the arrow buttons on the projector or the remote control to select the corner of the image you want to adjust. Then press **Enter**.

7. Press the arrow buttons to adjust the image shape as necessary.
8. When you are finished, press **Esc**.

Parent topic: [Image Shape](#)

Resizing the Image with the Zoom Ring

1. Turn on the projector and display an image.

Note: You can also display the pattern by pressing the **User** button on the remote control (if the test pattern is assigned to this button).

2. To enlarge or reduce the image size, rotate the projector's zoom ring.

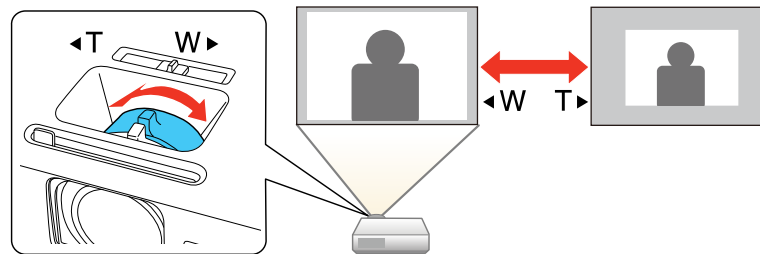

Parent topic: [Using Basic Projector Features](#)

Focusing the Image Using the Focus Ring

You can correct the focus using the focus ring.

1. Turn on the projector and display an image.

Note: You can display a pattern to aid in adjusting the projected image using the Settings menu.

Note: You can also display the pattern by pressing the **User** button on the remote control (if the test pattern is assigned to this button).

2. To sharpen the image focus, rotate the projector's focus ring.

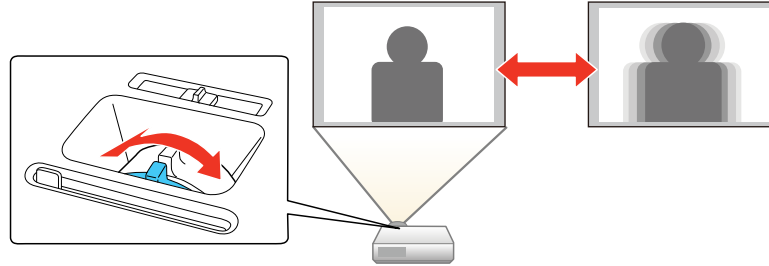

Parent topic: [Using Basic Projector Features](#)

Remote Control Operation

The remote control lets you control the projector from almost anywhere in the room. You can point it at the screen, or the front or back of the projector.

Make sure that you aim the remote control at the projector's receivers within the distance and angles listed here.

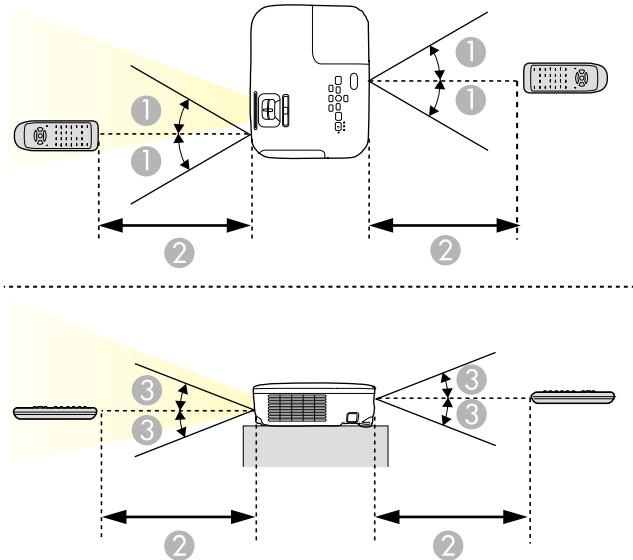

- 1 30°
- 2 19.7 feet (6 m)
- 3 15°

Note: Avoid using the remote control in conditions with bright fluorescent lights or in direct sunlight, or the projector may not respond to commands. If you will not use the remote control for a long time, remove the batteries.

[Using the Remote Control as a Wireless Mouse](#)

[Using the Remote Control as a Pointer](#)



Parent topic: [Using Basic Projector Features](#)

Using the Remote Control as a Wireless Mouse

You can use the projector's remote control as a wireless mouse so you can control projection at a distance from the computer. The computer must be running Windows Vista or later, OS X 10.7 or later, macOS 10.12.x, or macOS 10.13.x.

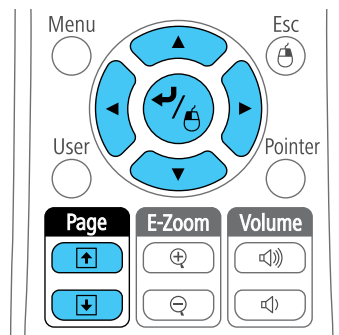
1. Connect the projector to a computer using the projector's **USB-B**, **Computer**, or **HDMI** port to display video.
2. If you connected your computer to a port other than the projector's **USB-B** port, also connect a USB cable to the projector's **USB-B** port and to a USB port on your computer (for wireless mouse support).
3. Start your presentation.
4. Use the following buttons on the remote control to control your presentation:
 - To move through slides or pages, press the up or down **Page** buttons.



- To move the cursor on the screen, use the arrow buttons.
- To left-click, press the  button once (press it twice to double-click).
- To right-click, press the **Esc** button.
- To drag-and-drop, hold the  button as you move the cursor with the arrow buttons, then release  at the destination.

Parent topic: [Remote Control Operation](#)

Related tasks

[Connecting to a Computer for USB Mouse Control](#)

Using the Remote Control as a Pointer

You can use the projector's remote control as a pointer to help you call out important information on the screen. The default pointer shape is an arrow, but you can select an alternative shape using the Settings menu.

1. Press the **Pointer** button on the remote control.
2. Use the arrow buttons on the remote control to move the pointer on the screen.

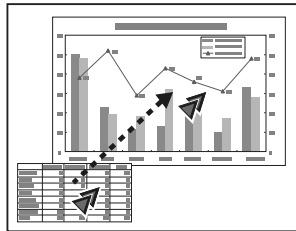

3. Press **Esc** to clear the pointer from the screen.

Parent topic: [Remote Control Operation](#)

Selecting an Image Source

If you connected multiple image sources to the projector, such as a computer and DVD player, you may want to switch from one image source to the other.

Note: If you turned on the **Auto Source Search** setting in the Extended menu, the projector automatically switches to another detected image source if the signal to the current image source is lost.

1. Make sure the connected image source you want to use is turned on.
2. For video image sources, insert a DVD or other video media and press its play button, if necessary.
3. Do one of the following:
 - Press the **Source Search** button on the projector or remote control until you see the image from the source you want.

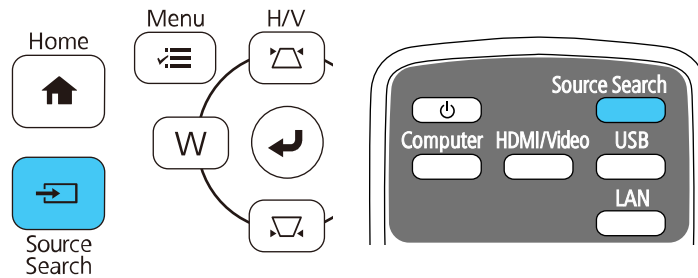

- Press the button for the source you want on the remote control. If there is more than one port for that source, press the button again to cycle through the sources.

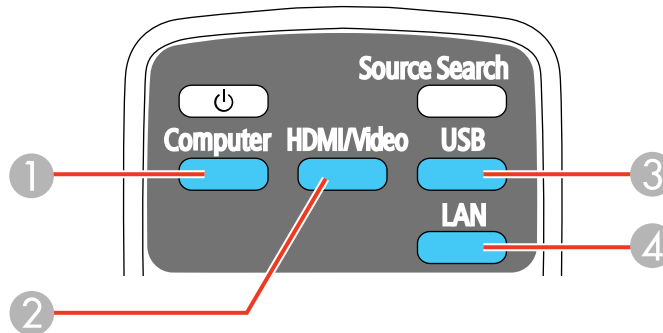

- 1 Computer port sources
- 2 Video, HDMI, and MHL sources
- 3 USB port sources (computer display and external devices)
- 4 Network source (LAN)

- Press the **Home** button on the remote control and select your image source.



Note: Your Home screen may look different from the illustration shown here.

Parent topic: [Using Basic Projector Features](#)

Projection Modes

Depending on how you positioned the projector, you may need to change the projection mode so your images project correctly.

- **Front** (default setting) lets you project from a table in front of the screen.
- **Front/Ceiling** flips the image over top-to-bottom to project upside-down from a ceiling or wall mount.
- **Rear** flips the image horizontally to project from behind a translucent screen.
- **Rear/Ceiling** flips the image over top-to-bottom and horizontally to project from the ceiling and behind a translucent screen.

[Changing the Projection Mode Using the Remote Control](#)

[Changing the Projection Mode Using the Menus](#)

Parent topic: [Using Basic Projector Features](#)

Changing the Projection Mode Using the Remote Control

You can change the projection mode to flip the image over top-to-bottom.

1. Turn on the projector and display an image.
2. Hold down the **A/V Mute** button on the remote control for 5 to 10 seconds.

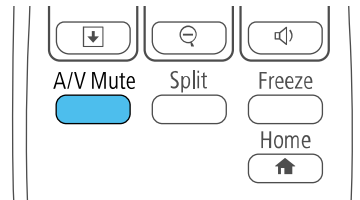

The image disappears briefly and reappears flipped top-to-bottom.

3. To change projection back to the original mode, hold down the **A/V Mute** button for 5 to 10 seconds again.

Parent topic: [Projection Modes](#)

Changing the Projection Mode Using the Menus

You can change the projection mode to flip the image over top-to-bottom and/or left-to-right using the projector menus.

1. Turn on the projector and display an image.
2. Press the **Menu** button.

3. Select the **Extended** menu and press **Enter**.

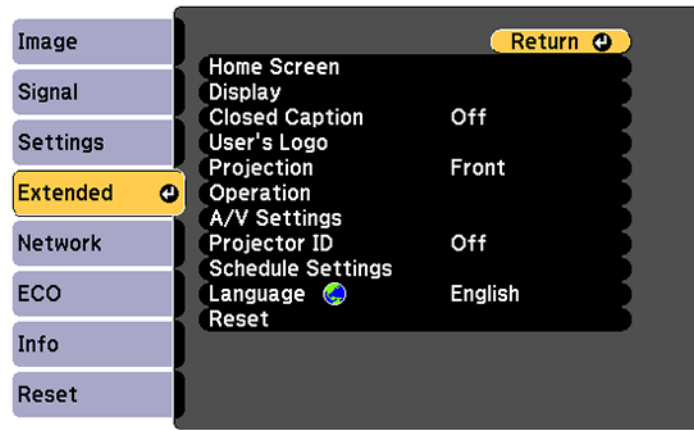

4. Select the **Projection** setting and press **Enter**.
5. Select a projection mode and press **Enter**.
6. Press **Menu** or **Esc** to exit the menus.

Parent topic: [Projection Modes](#)

Image Aspect Ratio

The projector can display images in different width-to-height ratios called aspect ratios. Normally the input signal from your video source determines the image's aspect ratio. However, for certain images you can change the aspect ratio to fit your screen by pressing a button on the remote control.

If you always want to use a particular aspect ratio for a certain video input source, you can select it using the projector's menus.

[Changing the Image Aspect Ratio](#)

[Available Image Aspect Ratios](#)

Parent topic: [Using Basic Projector Features](#)

Changing the Image Aspect Ratio

You can change the aspect ratio of the displayed image to resize it.

1. Turn on the projector and switch to the image source you want to use.

2. Press the **Aspect** button on the remote control.

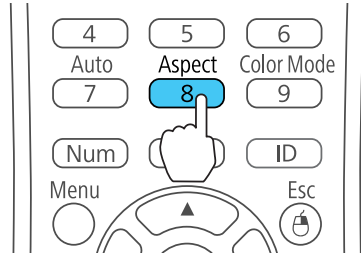

The shape and size of the displayed image changes, and the name of the aspect ratio appears briefly on the screen.

3. To cycle through the available aspect ratios for your input signal, press the **Aspect** button repeatedly.

Note: If you are projecting from a computer and parts of the image are cut off, set the **Resolution** setting to **Wide** or **Normal** in the Signal menu.

Parent topic: [Image Aspect Ratio](#)

Related references

[Input Signal Settings - Signal Menu](#)

Available Image Aspect Ratios

You can select the following image aspect ratios, depending on the input signal from your image source.

Note: Black bands and cropped images may project in certain aspect ratios, depending on the aspect ratio and resolution of your input signal.

PowerLite 109W/980W/990U

Aspect ratio setting	Description
Auto	Automatically sets the aspect ratio according to the input signal and the Resolution setting.
Normal	Displays images using the full projection area and maintains the aspect ratio of the image.

Aspect ratio setting	Description
16:9	Converts the aspect ratio of the image to 16:9.
Full	Displays images using the full width of the projection area, but does not maintain the aspect ratio.
Zoom	Displays images using the full width of the projection area and maintains the aspect ratio of the image.
Native	Displays images as is (aspect ratio and resolution are maintained).

PowerLite 107/108/970

Aspect ratio setting	Description
Auto	Automatically sets the aspect ratio according to the input signal and the Resolution setting.
Normal	Displays images using the full projection area and maintains the aspect ratio of the image.
4:3	Displays images using the full projection area at 4:3 aspect ratio.
16:9	Converts the aspect ratio of the image to 16:9.

Note: The **Auto** aspect ratio setting is available only for HDMI image sources.

Parent topic: [Image Aspect Ratio](#)

Color Mode

The projector offers different Color Modes to provide optimum brightness, contrast, and color for a variety of viewing environments and image types. You can select a mode designed to match your image and environment, or experiment with the available modes.

If you always want to use a particular color mode for a certain video input source, you can select it using the projector menus.

[Changing the Color Mode](#)

[Available Color Modes](#)

[Turning On Auto Iris](#)

Parent topic: [Using Basic Projector Features](#)

Changing the Color Mode

You can change the projector's Color Mode using the remote control to optimize the image for your viewing environment.

1. Turn on the projector and switch to the image source you want to use.
2. If you are projecting from a DVD player or other video source, insert a disc or other video media and press the play button, if necessary.
3. Press the **Color Mode** button on the remote control to change the Color Mode.

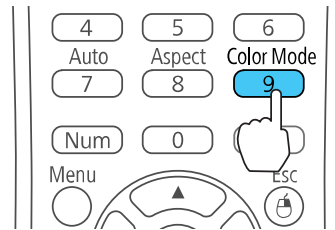

The image appearance changes and the name of the Color Mode appears briefly on the screen.

4. To cycle through all the available Color Modes for your input signal, press the **Color Mode** button repeatedly.

Parent topic: [Color Mode](#)

Available Color Modes

You can set the projector to use these Color Modes, depending on the input source you are using:

Color Mode	Description
Presentation	Best for color presentations in a bright room
Dynamic	Best for video games in a bright room
Cinema	Best for movies projected in a dark room
sRGB	Best for standard sRGB computer displays
Blackboard	Best for presentations onto a green chalkboard (adjusts the colors accordingly)

Parent topic: [Color Mode](#)

Turning On Auto Iris

In certain color modes, you can turn on the Auto Iris setting to automatically optimize the image based on the brightness of the content you project.

1. Turn on the projector and switch to the image source you want to use.
2. Press the **Menu** button.
3. Select the **Image** menu and press **Enter**.

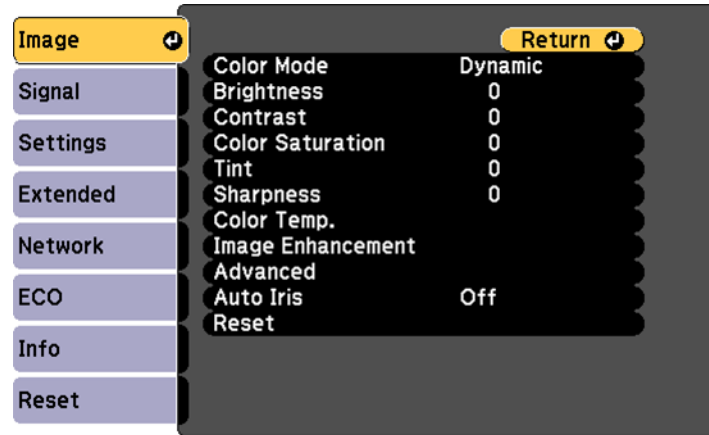

4. Select the **Auto Iris** setting and choose one of the following:
 - **High Speed** to adjust brightness as soon as the scene changes.
 - **Normal** for standard brightness adjustment.

Note: You can set **Auto Iris** for each Color Mode that supports the feature. You cannot change the **Auto Iris** setting when you are using a **Closed Caption** setting.

5. Press **Menu** or **Esc** to exit the menus.

Parent topic: [Color Mode](#)

Related references

[Projector Setup Settings - Extended Menu](#)

Controlling the Volume with the Volume Buttons

You can use the **Volume** buttons on the remote control or projector to adjust the volume as you project a presentation with audio. The volume buttons control the projector's internal speaker system or any external speakers you connected to the projector.

You must adjust the volume separately for each connected input source.

1. Turn on the projector and start a presentation that includes audio.
2. To lower or raise the volume, press the **Volume** buttons on the remote control or control panel.

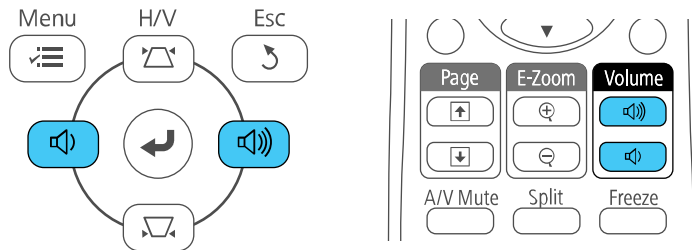

3. To set the volume to a specific level for an input source, use the projector menus.

Parent topic: [Using Basic Projector Features](#)

Projecting a PC Free Presentation

You can use your projector's PC Free feature whenever you connect a USB device that contains compatible files. This lets you quickly and easily display the contents of the files and control their display using the projector's remote control.

[Supported PC Free File Types](#)

[Starting a PC Free Slide Show](#)

[Starting a PC Free Movie Presentation](#)

[PC Free Display Options](#)

Parent topic: [Using Basic Projector Features](#)

Supported PC Free File Types

You can project these types of files using the projector's PC Free feature.

Note: For best results, place your files on media that is formatted in FAT16/32. If you have trouble projecting from media formatted for non-Windows file systems, try formatting the media for Windows instead. You may not be able to use the security features on certain USB storage devices with PC Free features. When connecting a USB-compatible hard drive, connect the AC adapter supplied with the drive. PC Free may not work with USB device security features.

File type and extension	Details
Image (.jpg)	Make sure the file is not: <ul style="list-style-type: none"> • CMYK format • Progressive format • Highly compressed • Above 8192 × 8192 resolution
Image (.bmp)	Make sure the file resolution is not above 1280 × 800
Image (.gif)	Make sure the file is not: <ul style="list-style-type: none"> • Above 1280 × 800 resolution • Animated
Image (.png)	Make sure the file resolution is not above 1280 × 800
Motion JPEG movie (.avi)	Supports only AVI 1.0 Make sure the file is not: <ul style="list-style-type: none"> • Saved with an audio codec other than PCM or ADPCM • Above 1280 × 720 resolution • Larger than 2GB

Parent topic: [Projecting a PC Free Presentation](#)

Starting a PC Free Slide Show

After connecting a USB device or digital camera to the projector, you can switch to the USB input source and start your slide show.

Note: You can change the PC Free operation options or add special effects by highlighting **Option** at the bottom of the screen and pressing **Enter**.

1. Press the **USB** button on the projector remote control.
The PC Free screen appears.



2. Do the following as necessary to locate your files:
 - If you need to display files inside a subfolder on your device, press the arrow buttons to highlight the folder and press the **Enter** button.
 - To move back up a folder level on your device, highlight **Back to Top** and press **Enter**.
 - To view additional files in a folder, highlight **Next page** or **Previous page** and press **Enter**.
3. Do one of the following:
 - To display an individual image, press the arrow buttons to highlight the image and press **Enter**. (Press the **Esc** button to return to the file list screen.)
 - To display a slide show of all the images in a folder, press the arrow buttons to highlight the **Slideshow** option at the bottom of the screen and press **Enter**.

Note: If any file names are longer than 8 characters or include unsupported symbols, the file names may be shortened or changed only in the screen display.

4. While projecting, use the following commands to control the display as necessary:
 - To rotate a displayed image, press the up or down arrow button.
 - To move to the next or previous image, press the left or right arrow button.
5. To stop the display, follow the on-screen instructions or press the **Esc** button.

Parent topic: [Projecting a PC Free Presentation](#)

Starting a PC Free Movie Presentation

After connecting a USB device or digital camera to the projector, you can switch to the USB input source and start your movie.

Note: You can change the PC Free operation options by highlighting **Option** at the bottom of the screen and pressing **Enter**.

1. Press the **USB** button on the projector remote control.

The PC Free screen appears.



2. Do the following as necessary to locate your files:
 - If you need to display files inside a subfolder on your device, press the arrow buttons to highlight the folder and press the **Enter** button.
 - To move back up a folder level on your device, highlight **Back to Top** and press **Enter**.
 - To view additional files in a folder, highlight **Next page** or **Previous page** and press **Enter**. (You can also press the **Page** up or down buttons on the remote control.)
 - To display movie files from a different USB drive, select **Select Drive** at the top of the PC Free screen and press **Enter**.
3. To play back a movie, press the arrow buttons to highlight the file and press **Enter**.

Note: If any file names are longer than 8 characters or include unsupported symbols, the file names may be shortened or changed only in the screen display. If you want to play back all the movies in a folder in sequence, select the **Slideshow** option at the bottom of the screen.

4. To stop movie playback, press the **Esc** button, highlight **Exit**, and press **Enter**.

Parent topic: [Projecting a PC Free Presentation](#)

PC Free Display Options

You can select these display options when using the projector's PC Free feature.

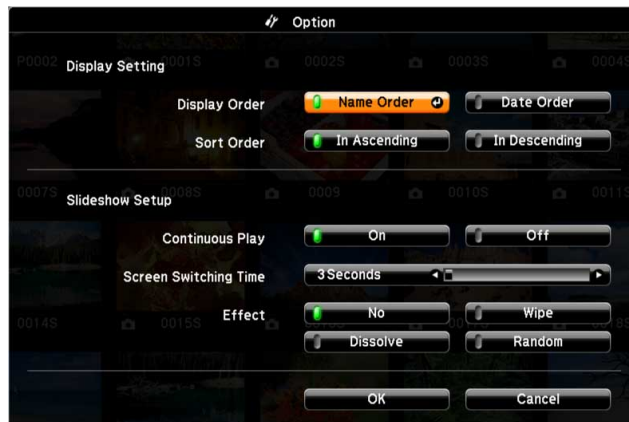

Setting	Options	Description
Display Order	Name Order	Displays files in name order
	Date Order	Displays files in date order
Sort Order	In Ascending	Sorts files in first-to-last order
	In Descending	Sorts files in last-to-first order
Continuous Play	On	Displays a slide show continuously
	Off	Displays a slide show one time through
Screen Switching Time	No	Does not display the next file automatically
	1 Second to 60 Seconds	Displays files for the selected time and switches to the next file automatically; high resolution images may switch at a slightly slower rate
Effect	Wipe	Transitions between images with a wipe effect
	Dissolve	Transitions between images with a dissolve effect
	Random	Transitions between images using a random variety of effects

Parent topic: [Projecting a PC Free Presentation](#)

Adjusting Projector Features

Follow the instructions in these sections to use your projector's feature adjustments.

[Shutting Off the Picture and Sound Temporarily](#)

[Stopping Video Action Temporarily](#)

[Zooming Into and Out of Images](#)

[Projector Security Features](#)

[Projector Identification System for Multiple Projector Control](#)

[Projecting Two Images Simultaneously](#)

[Copying Menu Settings Between Projectors](#)

Shutting Off the Picture and Sound Temporarily

You can temporarily turn off the projected picture and sound if you want to redirect your audience's attention during a presentation. Any sound or video action continues to run, however, so you cannot resume projection at the point that you stopped it.

If you want to display an image such as a company logo or picture when the presentation is stopped, you can set up this feature using the projector's menus.

Note: If the picture and sound are off for more than 30 minutes, the power automatically turns off. You can turn this setting on and off using the projector's **ECO** menu.

Note: The lamp is still lit while using A/V Mute and the lamp hours will continue to accumulate.

1. Press the **A/V Mute** button on the remote control to temporarily stop projection and mute any sound.

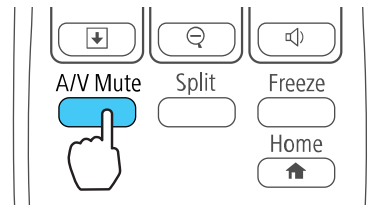

2. To turn the picture and sound back on, press the **A/V Mute** button again.

Note: You can also stop projection using the **A/V Mute** slide lever on the projector.

Parent topic: [Adjusting Projector Features](#)

Related references

[Projector Setup Settings - ECO Menu](#)

Related tasks

[Saving a User's Logo Image to Display](#)

Stopping Video Action Temporarily

You can temporarily stop the action in a video or computer presentation and keep the current image on the screen. Any sound or video action continues to run, however, so you cannot resume projection at the point that you stopped it.

1. Press the **Freeze** button on the remote control to stop the video action.

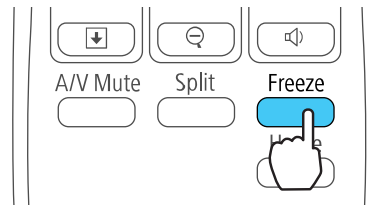

2. To restart the video action in progress, press **Freeze** again.

Parent topic: [Adjusting Projector Features](#)

Zooming Into and Out of Images

You can draw attention to parts of a presentation by zooming into a portion of the image and enlarging it on the screen.

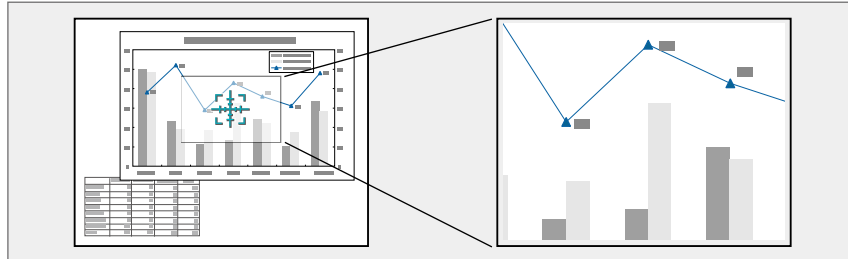

1. Press the **E-Zoom +** button on the remote control.

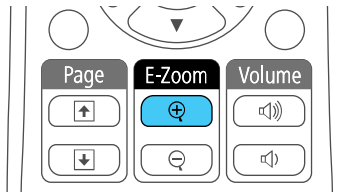

You see a crosshair on the screen indicating the center of the zoom area.

2. Use the following buttons on the remote control to adjust the zoomed image:
 - Use the arrow buttons to position the crosshair in the image area you want to zoom into.
 - Press the **E-Zoom +** button repeatedly to zoom into the image area, enlarging it as necessary. Press and hold the **E-Zoom +** button to zoom in more quickly.
 - To pan around the zoomed image area, use the arrow buttons.
 - To zoom out of the image, press the **E-Zoom –** button as necessary.
 - To return to the original image size, press **Esc**.

Parent topic: [Adjusting Projector Features](#)

Projector Security Features

You can secure your projector to deter theft or prevent unintended use by setting up the following security features:

- Password security to prevent the projector from being turned on, and prevent changes to the startup screen and other settings.
- Button lock security to block operation of the projector using the buttons on the control panel.
- Security cabling to physically cable the projector in place.

[Password Security Types](#)

[Locking the Projector's Buttons](#)

[Installing a Security Cable](#)

Parent topic: [Adjusting Projector Features](#)

Password Security Types

You can set up these types of password security using one shared password:

- **Power On Protection** password prevents anyone from using the projector without first entering a password.
- **User's Logo Protection** password prevents anyone from changing the custom screen the projector can display when it turns on. The presence of the custom screen discourages theft by identifying the projector's owner.
- **Network Protection** password prevents anyone from changing the network settings in the projector menus.

[Setting a Password](#)

[Selecting Password Security Types](#)

[Entering a Password to Use the Projector](#)

[Saving a User's Logo Image to Display](#)

Parent topic: [Projector Security Features](#)

Setting a Password

To use password security, you must set a password.

Note: The default password is set to **0000**.

1. Hold down the **Freeze** button on the remote control for about five seconds or until you see this menu.

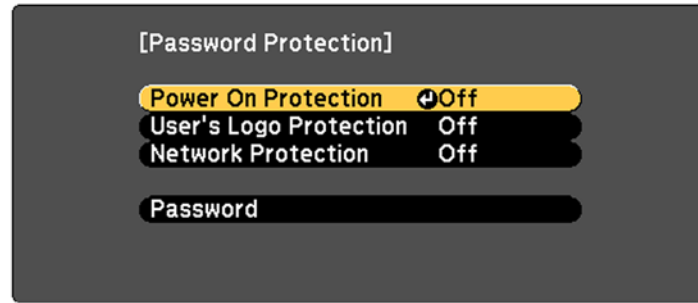

2. Press the down arrow to select **Password** and press **Enter**.
You see the prompt "Change the password?".
3. Select **Yes** and press **Enter**.
4. Press and hold down the **Num** button on the remote control and use the numeric buttons to set a four-digit password.

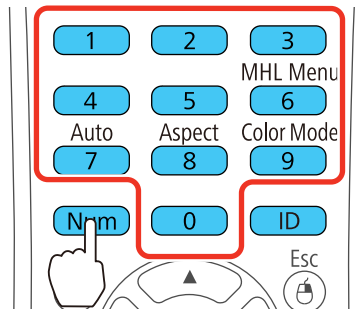

The password displays as **** as you enter it. Then you see the confirmation prompt.

5. Enter the password again.
You see the message "Password accepted."
6. Press **Esc** to return to the menu.
7. Make a note of the password and keep it in a safe place in case you forget it.

Parent topic: [Password Security Types](#)

Related tasks

[Selecting Password Security Types](#)

Selecting Password Security Types

After setting a password, you see this menu, allowing you to select the password security types you want to use.

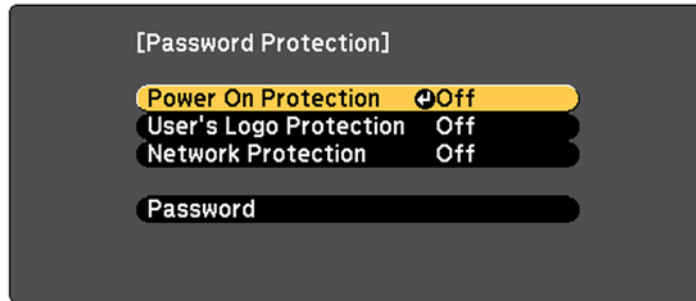

If you do not see this menu, hold down the **Freeze** button on the remote control for about five seconds or until the menu appears.

- To prevent unauthorized use of the projector, select **Power On Protection**, press **Enter**, select **On**, press **Enter** again, and press **Esc**.
- To prevent changes to the User's Logo screen or related display settings, select **User's Logo Protection**, press **Enter**, select **On**, press **Enter** again, and press **Esc**.
- To prevent changes to network settings, select **Network Protection**, press **Enter**, select **On**, press **Enter** again, and press **Esc**.

Note: Be sure to keep the remote control in a safe place; if you lose it, you will not be able to enter the password required to use the projector.

Parent topic: [Password Security Types](#)

Related tasks

[Setting a Password](#)

Entering a Password to Use the Projector

If a password is set up and a **Power On Protection** password is enabled, you see a prompt to enter a password whenever you turn on the projector.

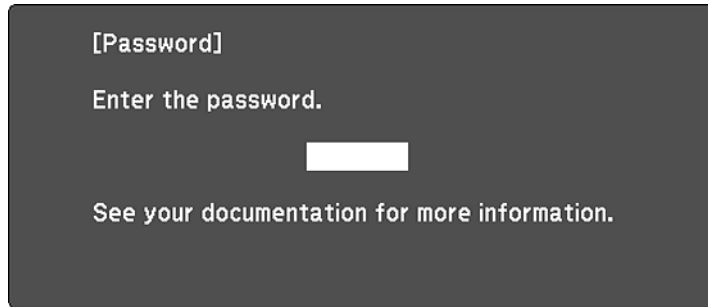

[0-9] :Enter

You must enter the correct password to use the projector.

1. Press and hold down the **Num** button on the remote control while you enter the password using the numeric buttons.

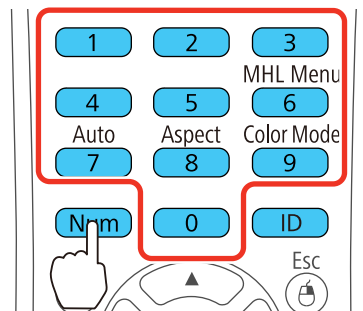

Note: The default password is **0000**.

The password screen closes.

2. If the password is incorrect, the following may happen:
 - You see a "wrong password" message and a prompt to try again. Enter the correct password to proceed.
 - If you enter an incorrect password three times in succession, you see a message telling you that the projector is locked. After the message is displayed for 5 minutes, the projector enters standby mode. Unplug the projector, plug in the power cord, and turn on the projector. You see a prompt to enter the password.
 - If you continue to enter an incorrect password many times in succession, the projector displays a request code and a message to contact Epson Support. Do not attempt to enter the password again. When you contact Epson Support, provide the displayed request code and proof of ownership for assistance in unlocking the projector.

Parent topic: [Password Security Types](#)

Related references

[Where to Get Help](#)

Saving a User's Logo Image to Display

You can transfer an image to the projector and then display it whenever the projector turns on. You can also display the image when the projector is not receiving an input signal or when you temporarily stop projection (using the A/V Mute feature). This transferred image is called the User's Logo screen.

The image you select as the User's Logo can be a photo, graphic, or company logo, which is useful in identifying the projector's owner to help deter theft. You can prevent changes to the User's Logo by setting up password protection for it.

Note: When you copy the menu settings from one projector to another using the batch setup feature, the user logo is also copied. Do not include any information in the user logo that you do not want to share between multiple projectors.

1. Display the image you want to project as the User's Logo.

2. Press the **Menu** button, select the **Extended** menu, and press **Enter**.

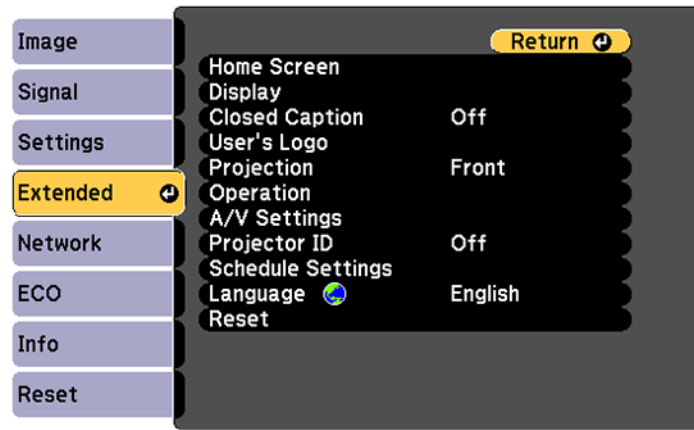

3. Select the **User's Logo** setting and press **Enter**.

You see a prompt asking if you want to use the displayed image as a user's logo.

4. Select **Yes** and press **Enter**.

You see a selection box overlaying your image.

Note: When you select **User's Logo**, adjustments such as **Keystone**, **E-Zoom**, or **Aspect** are temporarily canceled.

5. Use the arrow buttons on the remote control to surround the image area you want to use as the User's Logo and press **Enter**.

You see a prompt asking if you want to select this image area.

6. Select **Yes** and press **Enter**. (If you want to change the selected area, select **No**, press **Enter**, and repeat the last step.)

You see the User's Logo zoom factor menu.

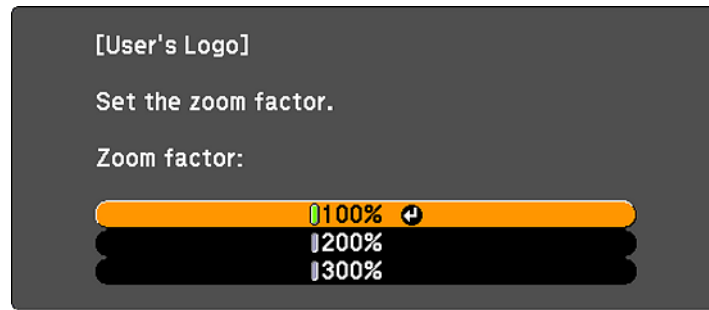

7. Select a zoom percentage and press **Enter**.
You see a prompt asking if you want to save the image as the User's Logo.
8. Select **Yes** and press **Enter**.
You see a completion message.
9. Press **Esc** to exit the message screen.
10. Select the **Extended** menu and press **Enter**.
11. Select **Display** and press **Enter**.
12. Select when you want to display the User's Logo screen:
 - To display it whenever there is no input signal, select **Display Background** and set it to **Logo**.
 - To display it whenever you turn the projector on, select **Startup Screen** and set it to **On**.
 - To display it whenever you press the **A/V Mute** button, select **A/V Mute** and set it to **Logo**.

To prevent anyone from changing the User's Logo settings without first entering a password, set a password and enable User's Logo security.

Parent topic: [Password Security Types](#)

Locking the Projector's Buttons

You can lock the buttons on the projector's control panel to prevent anyone from using the projector. You can lock all the buttons or all the buttons except the power button.

Note: The projector can still be operated using the remote control.

1. Press the **Menu** button.
2. Select the **Settings** menu and press **Enter**.

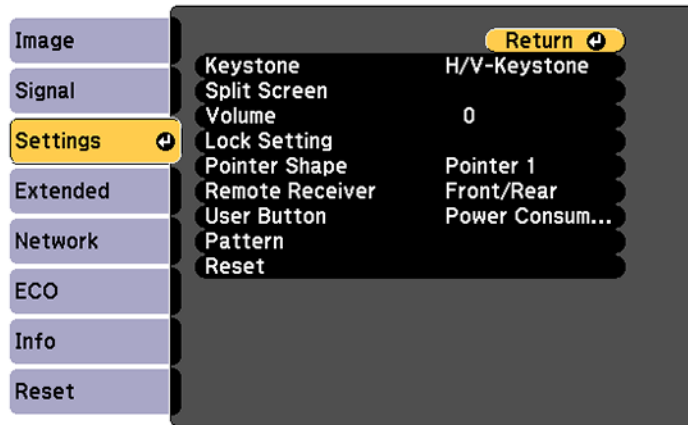

3. Select **Lock Setting** and press **Enter**.
 4. Select the **Control Panel Lock** setting and press **Enter**.
 5. Select one of these lock types and press **Enter**:
 - To lock all of the projector's buttons, select **Full Lock**.
 - To lock all buttons except the power button, select **Partial Lock**.
- You see a confirmation prompt.
6. Select **Yes** and press **Enter**.

[Unlocking the Projector's Buttons](#)

Parent topic: [Projector Security Features](#)

Unlocking the Projector's Buttons

If the projector's buttons have been locked, hold the **Enter** button on the projector's control panel for seven seconds to unlock them. You can also set the **Control Panel Lock** setting to **Off** in the Settings menu.

Parent topic: [Locking the Projector's Buttons](#)

Installing a Security Cable

You can install two types of security cables on the projector to deter theft.

- Use the security slot on the projector to attach a Kensington lock. See your local computer or electronics dealer for purchase information.
- Use the security cable attachment point on the projector to attach a wire cable and secure it to a room fixture or heavy furniture.

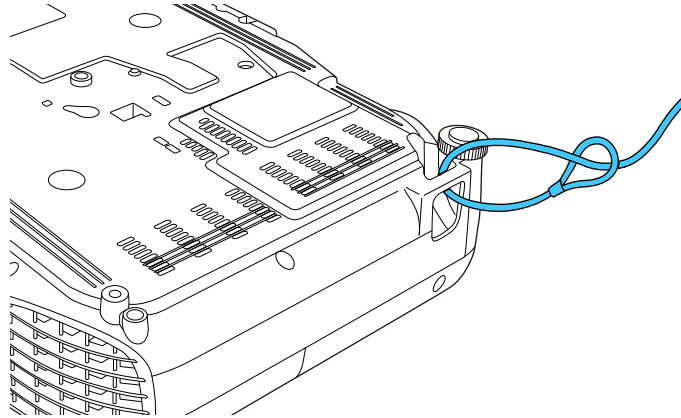

Note: Do not pass drop-prevention cables through the security cable attachment point when mounting the projector on a wall or ceiling.

Parent topic: [Projector Security Features](#)

Projector Identification System for Multiple Projector Control

You can operate multiple projectors using one remote control for more elaborate presentations. To do this, you assign an identification number to each projector and to the remote control. Then you can operate all the projectors at once or individually.

[Setting the Projector ID](#)

[Setting the Remote Control ID](#)

[Matching Multiple-Projector Display Quality](#)

Parent topic: [Adjusting Projector Features](#)

Setting the Projector ID

If you want to control multiple projectors from a remote control, give each projector a unique ID.

1. Press the **Menu** button.
2. Select the **Extended** menu and press **Enter**.
3. Select **Projector ID** and press **Enter**.

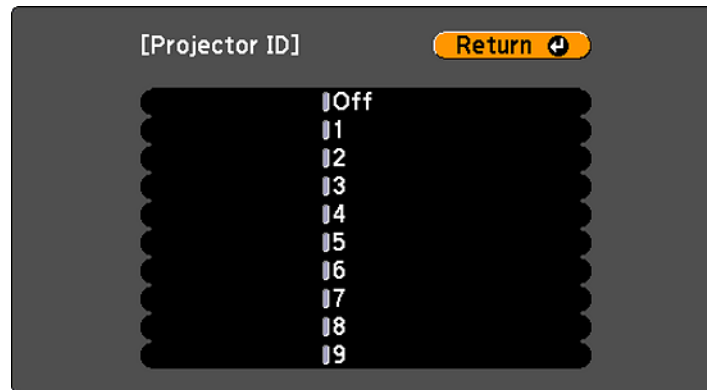

4. Press the arrow buttons on the remote control to select the identification number you want to use for the projector. Then press **Enter**.

Repeat these steps for all the other projectors you want to operate from one remote control.

Note: If you don't know the projector's ID, aim the remote control at the projector and press the **ID** button to temporarily display the projector's ID on the screen.

Parent topic: [Projector Identification System for Multiple Projector Control](#)

Setting the Remote Control ID

The remote control's ID is set to zero by default so it can operate any compatible projector. If you want to set the remote control to operate only a particular projector, you need to set the remote control's ID to match the projector's ID.

Note: You must set the remote control ID to match the projector ID each time you turn on the projector you have set it to control.

1. Turn on the projector you want the remote control to operate with exclusively.
2. Make sure you know the projector's ID number as set in the Extended menu **Projector ID** setting.

Note: If you have forgotten the projector's ID, aim the remote control at the projector and press the **ID** button to temporarily display the projector's ID on the screen. If you turn off the **Projector ID** setting, the remote control will operate the projector regardless of the ID selected on the remote.

3. Aim the remote control at that projector.
4. Hold down the **ID** button on the remote control while you press the numeric button that matches the projector's ID. Then release the buttons.

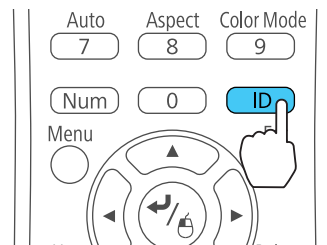

5. Press the **ID** button on the remote control to check if the ID-setting process worked.
You see a message displayed by the projector.
 - If the remote control is listed as **On**, the remote control ID is set to operate only the listed projector.
 - If the remote control is listed as **Off**, the remote control ID is not set properly. Repeat the steps above to set the ID to match the projector you want to control.

Parent topic: [Projector Identification System for Multiple Projector Control](#)

Matching Multiple-Projector Display Quality

You can match the display quality of multiple projectors that will project next to each other.

1. Turn on all the projectors on which you want to match the display quality.
2. Set ID numbers on each projector.
3. Set the remote control ID to match the first projector.

4. Press the **Menu** button, select the **Image** menu, and press **Enter**.

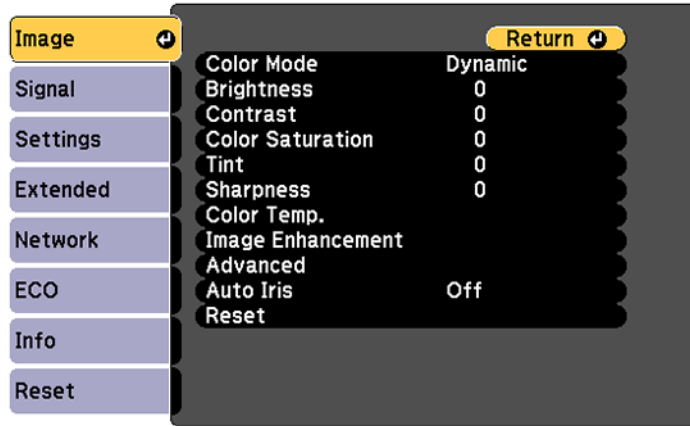

5. Select settings as necessary.
6. Set the remote control ID to match the next projector, then select Image menu adjustments as necessary to match the projectors' displays.

Note: The brightness and tint may not match exactly even after adjustments. If brightness and tint differences become more noticeable over time, repeat the adjustments.

Parent topic: [Projector Identification System for Multiple Projector Control](#)

Projecting Two Images Simultaneously

You can use the split screen feature to simultaneously project two images from different image sources next to each other. You can control the split screen feature using the remote control, the projector menus, or the interactive function.

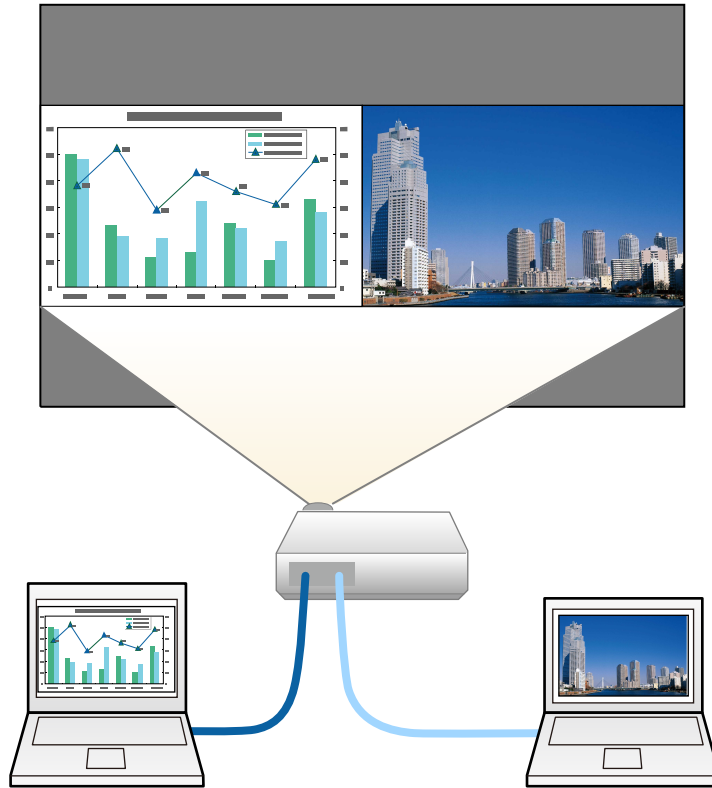

Note: While you use the split screen feature, other projector features may not be available and some settings may be automatically applied to both images.

Note: You cannot use split screen with certain input source combinations.

1. Press the **Split** button on the remote control.

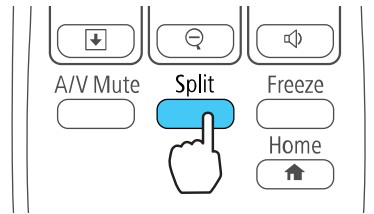

The currently selected input source moves to the left side of the screen.

2. Press the **Menu** button.

You see this screen:

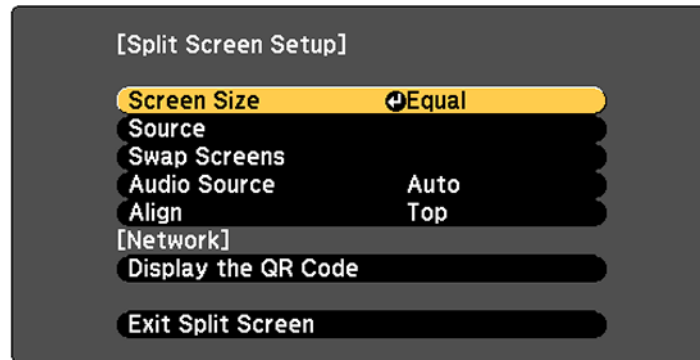

3. To select an input source for the other image, select the **Source** setting, press **Enter**, select the input source, select **Execute**, and press **Enter**. (You can also change image sources, if necessary.)
4. To switch the images, select the **Swap Screens** setting and press **Enter**.
5. To change the image sizes, select the **Screen Size** setting, press **Enter**, select a sizing option, press **Enter**, and press **Menu** to exit.

Note: Depending on the video input signals, the images may not appear at the same size even if you choose the **Equal** setting.

6. To choose the audio you want to hear, select the **Audio Source** setting, press **Enter**, select an audio option, press **Enter**, and press **Menu** to exit.
7. To align the projected images, select the **Align** setting, press **Enter**, select the setting, press **Enter**, and press **Menu** to exit.
8. To exit the split screen feature, press the **Split** or **Esc** button.

Parent topic: [Adjusting Projector Features](#)

Copying Menu Settings Between Projectors

After you select menu settings for your projector, you can transfer them to another projector of the same model.

Note: Copy the projector's settings before you adjust the projected image using the projector's image adjustment settings. Any saved User's Logo setting on the projector will transfer to the other projector.

Caution: If the copy process fails due to a power failure, communication error, or for any other reason, Epson will not be responsible for any repair costs incurred.

The following settings will not transfer between projectors:

- Info menu items
- Network menu settings other than those in the Notifications and Others menus

[Saving Settings to a USB Flash Drive](#)

[Transferring Settings from a USB Flash Drive](#)

[Saving Settings to a Computer](#)

[Transferring Settings from a Computer](#)

Parent topic: [Adjusting Projector Features](#)

Saving Settings to a USB Flash Drive

You can save the projector settings you want to transfer to a USB flash drive.

Note: Use an empty flash drive. If the drive contains other files, the transfer may not complete correctly. The flash drive must use the FAT format and cannot have any security features.

1. Turn off the projector and unplug the power cord from the projector's power inlet.

2. Insert the flash drive into the **USB-A** port.

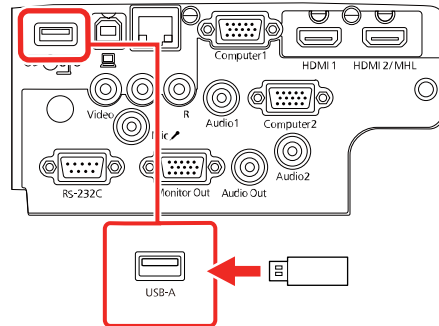

Note: Connect the flash drive directly to the projector. Do not use a hub or your settings may not be saved correctly.

3. Press and hold the **Esc** button on the control panel or remote control as you connect the power cord to the projector's power inlet.

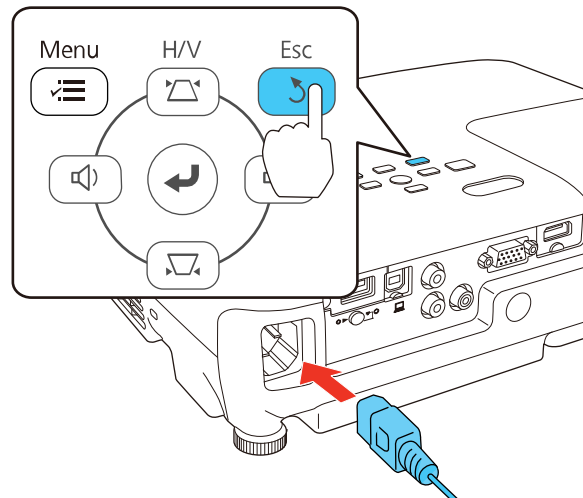

4. When all of the projector lights turn on, release the **Esc** button.

The lights flash to indicate that settings are transferring to the flash drive. When the lights stop flashing, the power light turns blue and the projector enters standby mode.

Caution: Do not unplug the power cord or remove the flash drive while the lights are flashing. This could damage the projector.

5. Once the projector enters standby mode, remove the flash drive.

Parent topic: [Copying Menu Settings Between Projectors](#)

Transferring Settings from a USB Flash Drive

After saving projector settings to a USB flash drive, you can transfer them to another projector of the same model.

Note: Make sure the USB flash drive contains only a single settings transfer from another projector of the same model. The settings are contained in a file called **pjconfdata.bin**. If the drive contains other files, the transfer may not complete correctly.

Do not adjust image settings on a projector until after you transfer settings to it. Otherwise, you may have to repeat your adjustments.

1. Turn off the projector and unplug the power cord from the projector's power inlet.
2. Insert the flash drive into the **USB-A** port.

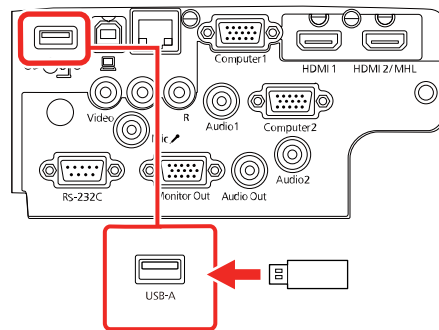

Note: Connect the flash drive directly to the projector. Do not use a hub or your settings may not be saved correctly.

3. Press and hold the **Menu** button on the control panel or remote control as you connect the power cord to the projector's power inlet.

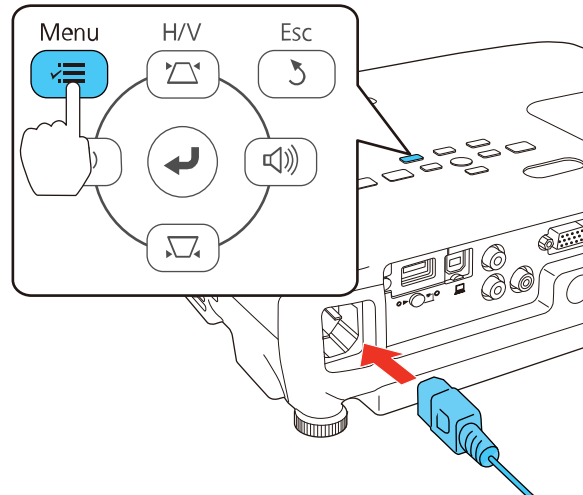

4. When all of the projector lights turn on, release the **Menu** button.
The lights flash to indicate that settings are transferring to the projector. When the lights stop flashing, the power light turns blue and the projector enters standby mode.

Caution: Do not unplug the power cord or remove the flash drive while the lights are flashing. This could damage the projector.

5. Once the projector enters standby mode, remove the flash drive.

Parent topic: [Copying Menu Settings Between Projectors](#)

Saving Settings to a Computer

You can save the projector settings you want to transfer to a computer.

Your computer must be running one of the following operating systems:

- Windows Vista
- Windows 7
- Windows 8.x

- Windows 10
 - OS X 10.7.x
 - OS X 10.8.x
 - OS X 10.9.x
 - OS X 10.10.x
 - OS X 10.11.x
 - macOS 10.12.x
 - macOS 10.13.x
1. Turn off the projector and unplug the power cord from the projector's power inlet.
 2. Connect a USB cable to your projector's **USB-B** port.

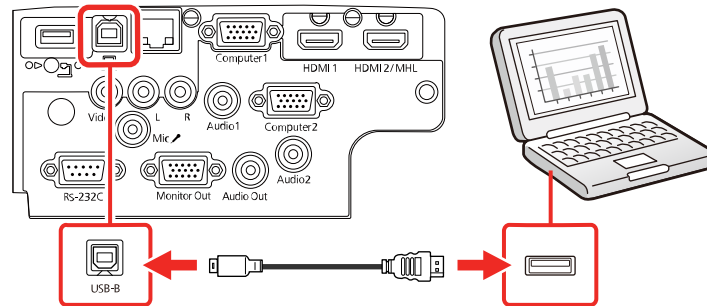

3. Connect the other end to any available USB port on your computer.

4. Press and hold the **Esc** button on the control panel or remote control as you connect the power cord to the projector's power inlet.

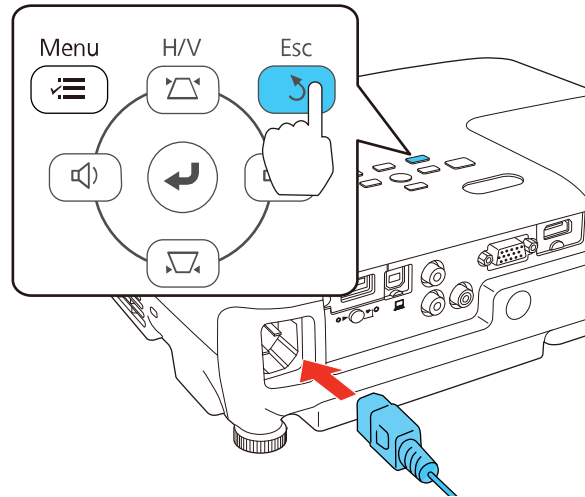

5. When all of the projector lights turn on, release the **Esc** button.
The projector shows up as a removable disk on your computer.
6. Open the removable disk and copy the **pjconfdata.bin** file to your computer.
7. Once the file has copied, do one of the following:
 - **Windows:** Open the **My Computer**, **Computer**, or **Windows Explorer** utility. Open the **My Computer**, **Computer**, **Windows Explorer**, or **File Explorer** utility. Right-click the name of your projector (listed as a removable disk) and select **Eject**.
 - **Mac:** Drag the removable disk icon for your projector from the desktop into the trash.The projector enters standby mode.

Parent topic: [Copying Menu Settings Between Projectors](#)

Transferring Settings from a Computer

After saving projector settings to a computer, you can transfer them to another projector of the same model.

Your computer must be running one of the following operating systems:

- Windows Vista
- Windows 7
- Windows 8.x
- Windows 10
- OS X 10.7.x
- OS X 10.8.x
- OS X 10.9.x
- OS X 10.10.x
- OS X 10.11.x
- macOS 10.12.x
- macOS 10.13.x

Do not adjust image settings on a projector until after you transfer settings to it. Otherwise, you may have to repeat your adjustments.

1. Turn off the projector and unplug the power cord from the projector's power inlet.
2. Connect a USB cable to your projector's **USB-B** port.

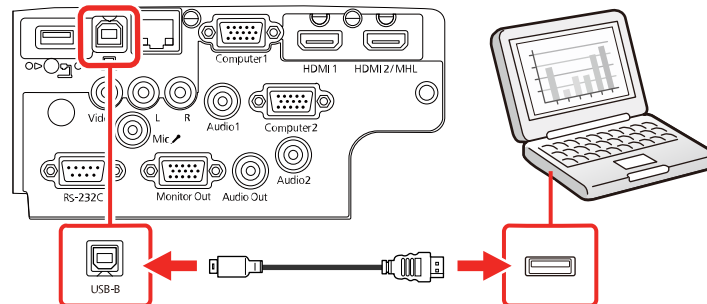

3. Connect the other end to any available USB port on your computer.

4. Press and hold the **Menu** button on the control panel or remote control as you connect the power cord to the projector's power inlet.

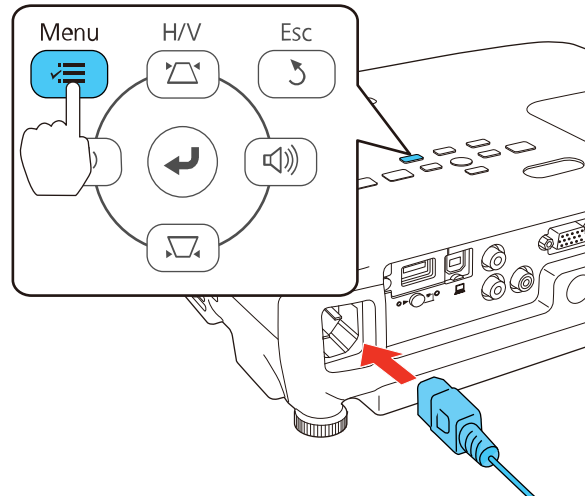

5. When all of the projector lights turn on, release the **Menu** button.
The projector shows up as a removable disk on your computer.
6. Copy the **pjconfdata.bin** file from your computer to the removable disk.

Note: Do not copy any other files to the removable disk.

7. Once the file has copied, do one of the following:
 - **Windows:** Open the **My Computer**, **Computer**, or **Windows Explorer** utility. Open the **My Computer**, **Computer**, **Windows Explorer**, or **File Explorer** utility. Right-click the name of your projector (listed as a removable disk) and select **Eject**.
 - **Mac:** Drag the removable disk icon for your projector from the desktop into the trash.

All the lights start flashing to indicate that the projector's settings are being updated. When the lights stop flashing, the power light turns blue and the projector enters standby mode.

Caution: Do not unplug the power cord while the lights are flashing. This could damage the projector.

Parent topic: [Copying Menu Settings Between Projectors](#)

Adjusting the Menu Settings

Follow the instructions in these sections to access the projector menu system and change projector settings.

[Using the Projector's Menus](#)

[Image Quality Settings - Image Menu](#)

[Input Signal Settings - Signal Menu](#)

[Projector Feature Settings - Settings Menu](#)

[Projector Setup Settings - Extended Menu](#)

[Projector Network Settings - Network Menu](#)

[Projector Setup Settings - ECO Menu](#)

[Projector Information Display - Info Menu](#)

[Projector Reset Options - Reset Menu](#)

Using the Projector's Menus

You can use the projector's menus to adjust the settings that control how your projector works. The projector displays the menus on the screen.

1. Press the **Menu** button on the control panel or remote control.

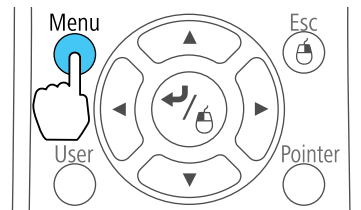
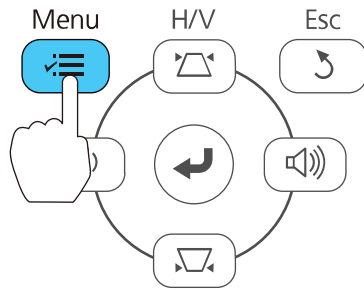

You see the menu screen displaying the Image menu settings.

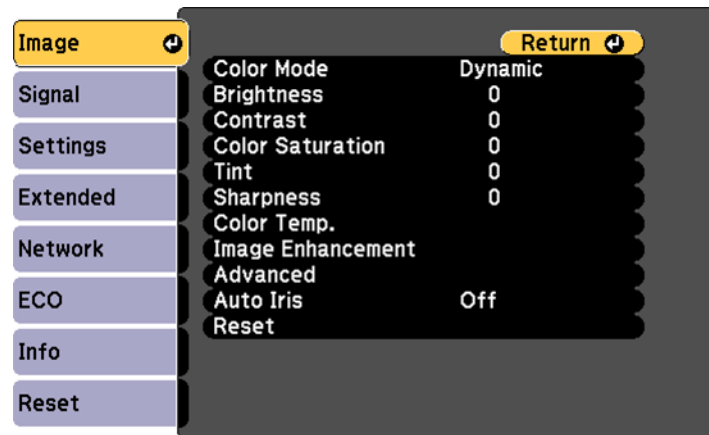

2. Press the up or down arrow button to move through the menus listed on the left. The settings for each menu are displayed on the right.

Note: The available settings depend on the current input source.

3. To change settings in the displayed menu, press **Enter**.
4. Press the up or down arrow button to move through the settings.
5. Change the settings using the buttons listed on the bottom of the menu screens.
6. To return all the menu settings to their default values, select **Reset**.
7. When you finish changing settings on a menu, press **Esc**.
8. Press **Menu** or **Esc** to exit the menus.

Parent topic: [Adjusting the Menu Settings](#)

Image Quality Settings - Image Menu

Settings on the Image menu let you adjust the quality of your image for the input source you are currently using. The available settings depend on the currently selected input source.

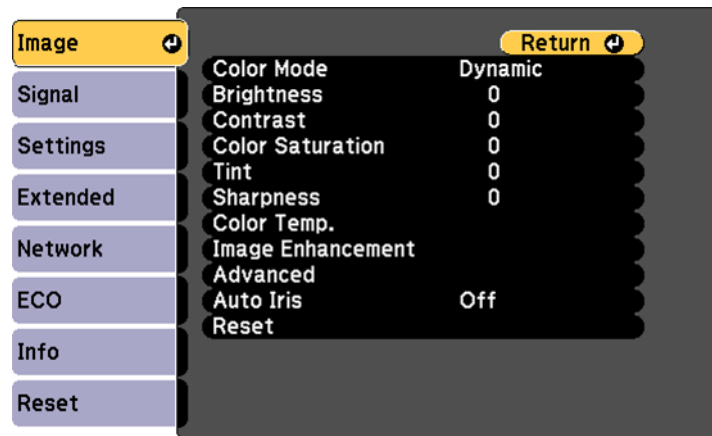

To change settings for an input source, make sure the source is connected and select that source.

Setting	Options	Description
Color Mode	See the list of available Color Modes	Adjusts the vividness of image colors for various image types and environments
Brightness	Varying levels available	Lightens or darkens the overall image
Contrast	Varying levels available	Adjusts the difference between light and dark areas of the image
Color Saturation	Varying levels available	Adjusts the intensity of the image colors
Tint	Varying levels available	Adjusts the balance of green to magenta tones in the image
Sharpness	Varying levels available	Adjusts the sharpness or softness of image details
Color Temp. (color temperature)	Color Temp. Customized	<p>Sets the overall color tone; high values tint the image blue (cool) and low values tint the image red (warm)</p> <p>Color Temp.: Sets the color tone in a range of 3200 to 10000 °K (Kelvin) for the sRGB Color Mode or 0 to 10 for all other Color Modes</p> <p>Customized: Adjusts the intensity of individual hues in the image; provides RGB-offset and gain controls for professional level color calibration</p>
Image Enhancement	Noise Reduction	Reduces flickering in analog images

Setting	Options	Description
Advanced	Deinterlacing	Sets whether to convert interlaced to progressive signals for certain video image types Off: for fast-moving video images Video: for most video images Film/Auto: for movies, computer graphics, and animation
Auto Iris	Off Normal High Speed	Adjusts the projected luminance based on the image brightness when the Dynamic or Cinema Color Modes are selected; High Speed sets faster luminance correction for fast-moving images

Note: The **Brightness** setting does not affect lamp brightness. To change the lamp brightness mode, use the **Power Consumption** setting in the ECO menu

Parent topic: [Adjusting the Menu Settings](#)

Related references

[Available Color Modes](#)

[Projector Setup Settings - ECO Menu](#)

Input Signal Settings - Signal Menu

Normally the projector detects and optimizes the input signal settings automatically. If you need to customize the settings, you can use the Signal menu. The available settings depend on the currently selected input source.

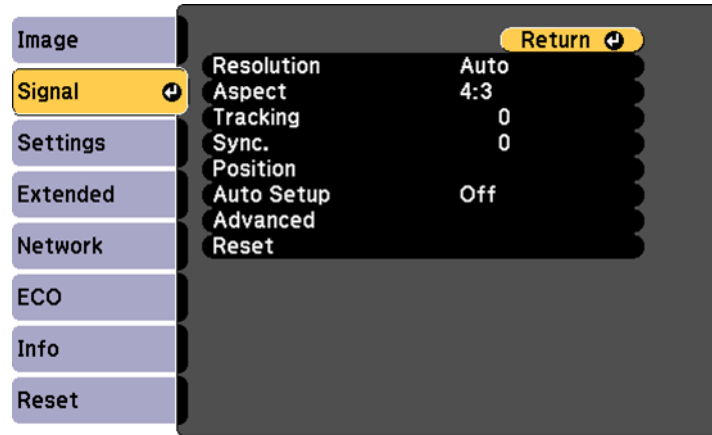

Note: You can restore the default settings of the **Position**, **Tracking**, and **Sync** settings by pressing the **Auto** button on the remote control.

To change settings for an input source, make sure the source is connected and select that source.

Setting	Options	Description
Resolution	Auto Wide Normal	Sets the input signal resolution if not detected automatically using the Auto option
Aspect	See the list of available aspect ratios	Sets the aspect ratio (width-to-height ratio) for the selected input source
Tracking	Varying levels available	Adjusts signal to eliminate vertical stripes in computer images

Setting	Options	Description
Sync.	Varying levels available	Adjusts signal to eliminate fuzziness or flickering in computer images
Position	Up, down, left, right	Adjusts the image location on the screen
Auto Setup	On Off	Automatically optimizes computer image quality (when On)
Overscan	Auto Off 4% 8%	Changes the projected image ratio to make the edges visible by a selectable percentage or automatically when using an HDMI input source
Advanced	—	See the Advanced settings table in this topic

Advanced settings

Setting	Options	Description
HDMI Video Range	Auto Normal Expanded	<p>Sets the video range to match the setting of the device connected to the HDMI input port</p> <p>Auto: detects the video range automatically</p> <p>Normal: for images from a device other than a computer; select if the black areas of the image are too bright</p> <p>Expanded: for images from a computer; select if the image is too dark</p>

Setting	Options	Description
Input Signal	Auto RGB Component	Specifies the signal type from input sources connected to computer ports Auto: detects signals automatically RGB: corrects color for computer/RGB video inputs Component: corrects color for component video inputs
Video Signal	Auto Various video standards	Specifies the signal type from the input sources connected to the video ports Auto: detects signals automatically

Parent topic: [Adjusting the Menu Settings](#)

Projector Feature Settings - Settings Menu

Options on the Settings menu let you customize various projector features. The available settings depend on the currently selected input source.

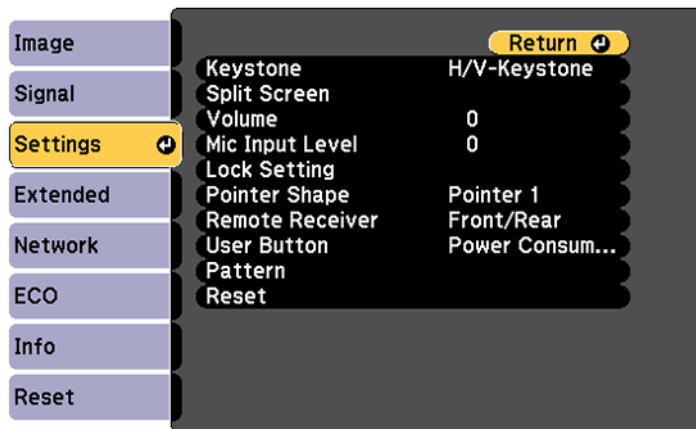

Setting	Options	Description
Keystone	H/V Keystone Quick Corner	Adjusts image shape to rectangular (horizontally and vertically) H/V Keystone: lets you manually correct horizontal and vertical sides Quick Corner: select to correct image shape and alignment using an on-screen display
Split Screen	Screen Size Source Swap Screens Audio Source Align Display the QR Code	Divides the viewing area horizontally and displays two images side-by-side (press Esc to cancel split screen display)
Volume	Varying levels available	Adjusts the volume of the projector's speaker system; you can set the volume level for each input source separately
Mic Input Level	Varying levels available	Adjusts the volume of the projector's speaker system when you use a connected microphone
Lock Setting	Control Panel Lock	Controls projector button locking to secure the projector Full Lock: locks all buttons Partial Lock: locks all buttons except the power button Off: no buttons locked
Pointer Shape	Three shapes available	Changes the shape of the remote control pointer feature

Setting	Options	Description
Remote Receiver	Front/Rear Front Rear Off	Limits reception of remote control signals by the selected receiver; Off turns off all receivers
User Button	Power Consumption Info Deinterlacing Closed Caption Test Pattern Resolution Mic Input Level Display the QR Code	Assigns a menu option to the User button on the remote control for one-touch access
Pattern	Pattern Display Pattern Type User Pattern Test Pattern	Selects various pattern display options

Parent topic: [Adjusting the Menu Settings](#)

Related tasks

[Using the Remote Control as a Pointer](#)

Projector Setup Settings - Extended Menu

Settings on the Extended menu let you customize various projector setup features that control its operation.

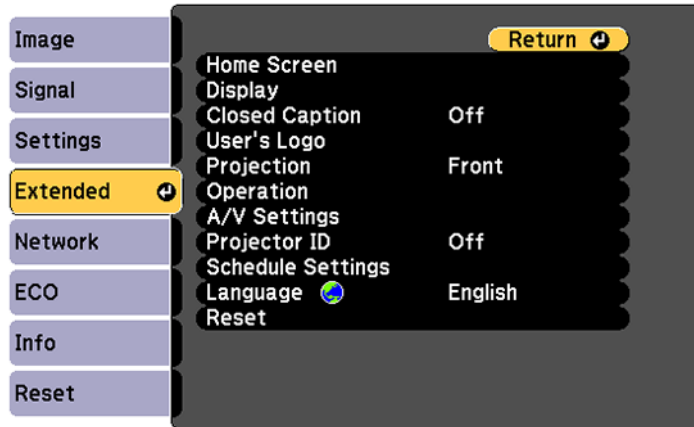

Setting	Options	Description
Home Screen	Home Screen Auto Disp. Custom Function 1 Custom Function 2	Select various options for the projector's Home screen Home Screen Auto Disp.: controls whether the Home screen displays automatically when the projector is turned on Custom Function 1/Custom Function 2: lets you customize the options displayed on the Home screen and save your settings as a preset

Setting	Options	Description
Display	Messages Display Background Startup Screen A/V Mute	Selects various display options Messages: controls whether messages are displayed on the screen Display Background: selects the screen color or logo to display when no signal is received Startup Screen: controls whether a special screen appears when the projector starts up A/V Mute: selects the screen color or logo to display when A/V Mute is turned on
Closed Caption	Off CC1 CC2	Controls use of closed captions and selects the closed caption type (closed captions are visible only for NTSC signals connected through the Video port)
User's Logo	—	Creates a screen that the projector displays to identify itself and enhance security
Projection	Front Front/Ceiling Rear Rear/Ceiling	Selects the way the projector faces the screen so the image is oriented correctly

Setting	Options	Description
Operation	Direct Power On High Altitude Mode Auto Source Search Auto Power On HDMI EQ Setting	Selects various operation options Direct Power On: turns on the projector when you plug it in High Altitude Mode: regulates the projector's operating temperature at altitudes above 4921 feet (1500 m) Auto Source Search: automatically detects the image signal being input when the projector is turned on Auto Power On: automatically turns on the projector when it receives an image signal (available only when Standby Mode is set to Communication On) HDMI EQ Setting: adjusts the HDMI input signal level depending on the connected device
A/V Settings	A/V Output Audio Output HDMI Audio Output	Selects the following when the projector is in standby mode (turned off) and the Standby Mode setting in the ECO menu is set to Communication On : A/V Output: Always On outputs sound and images to external equipment when the projector is turned off Audio Output: selects the audio source for sound; Auto outputs sound from the last selected image source HDMI Audio Output: selects the audio source for HDMI images
Projector ID	Off 1 through 9	Sets the projector to a particular ID number which allows you to use a remote control to individually control projectors

Setting	Options	Description
Schedule Settings	Schedule Schedule Reset Setup Complete	Schedules projector events to occur automatically at selected dates and times
Language	Various languages available	Selects the language for projector menu and message displays (not changed by Reset option)

Parent topic: [Adjusting the Menu Settings](#)

Projector Network Settings - Network Menu

Settings on the Network menu let you view network information and set up the projector for monitoring and control over a network.

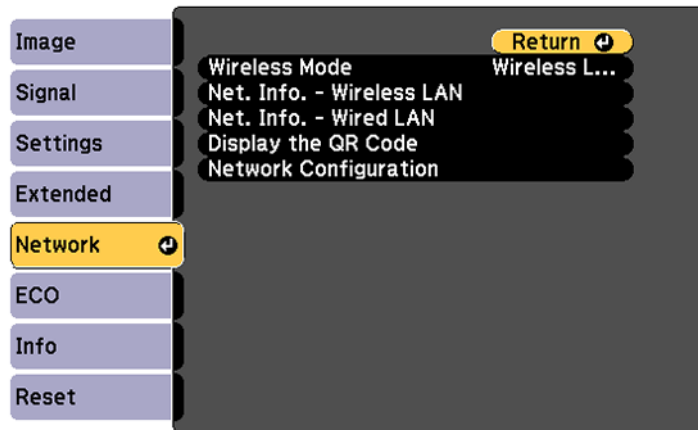

Setting	Options	Description
Wireless Mode	Wireless LAN On Off	Turns on wireless LAN mode

Setting	Options	Description
Net. Info - Wireless LAN	Connection mode Wireless LAN System Antenna level Projector Name SSID DHCP IP Address Subnet Mask Gateway Address MAC Address Region Code IPv6	Displays wireless network status and details
Net. Info - Wired Lan	Projector Name DHCP IP Address Subnet Mask Gateway Address MAC Address IPv6 Address (Manual) IPv6 Address (Auto)	Displays wired network status and details
Display the QR Code	—	Displays a QR code for connecting with iOS or Android devices using the Epson iProjection app
Network Configuration	Accesses additional network menus	Configures your network settings

Parent topic: [Adjusting the Menu Settings](#)

Related tasks

[Selecting Wired Network Settings](#)

Projector Setup Settings - ECO Menu

Settings on the ECO menu let you customize projector functions to save power. When you select a power-saving setting, a leaf icon appears next to the menu item.

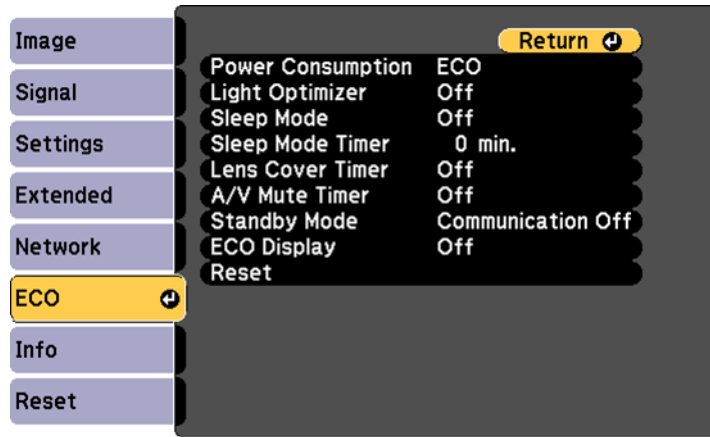

Setting	Options	Description
Power Consumption	Normal ECO	Selects the brightness mode of the projector lamp Normal: sets maximum lamp brightness ECO: reduces lamp brightness and fan noise, and saves power and lamp life
Light Optimizer	On Off	When Power Consumption is set to Normal and Auto Iris is turned off, the lamp brightness is adjusted based on the projected image; you can set this option for each color mode

Setting	Options	Description
Sleep Mode	On Off	Automatically places the projector in standby mode after an interval of inactivity
Sleep Mode Timer	1 to 30 minutes	Sets the interval for Sleep Mode
Lens Cover Timer	On Off	Automatically turns off the projector after 30 minutes if the lens cover is closed
A/V Mute Timer	On Off	Automatically turns off the projector after 30 minutes if A/V Mute is enabled
Standby Mode	Communication On Communication Off	Communication On indicates that the projector can be monitored and controlled over a network when the projector is in standby mode
ECO Display	On Off	Displays a leaf icon in the bottom left corner of the projected screen to indicate the power-saving status when the lamp brightness changes

Parent topic: [Adjusting the Menu Settings](#)

Projector Information Display - Info Menu

You can display information about the projector and input sources by viewing the Info menu. However, you cannot change any settings in the menu.

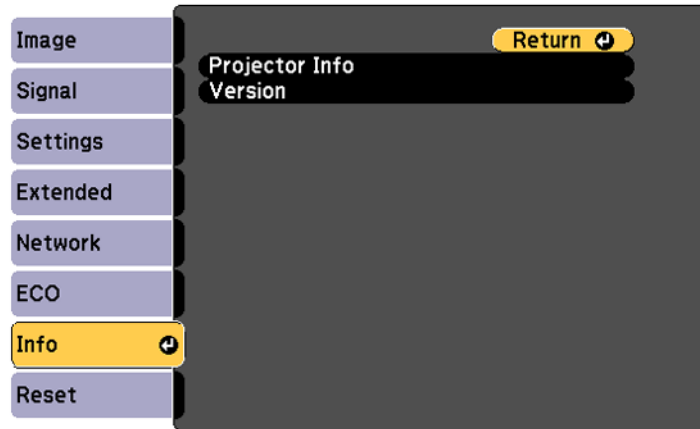

Select **Version** to display the projector's firmware version. Select **Projector Info** to display the settings described below.

Note: Available settings depend on the current input source. The lamp usage timer does not register any hours until you have used the lamp for at least 10 hours.

Information item	Description
Lamp Hours	Displays the number of hours (H) the lamp has been used in Normal and ECO Power Consumption modes; if the information is displayed in yellow, obtain a genuine Epson replacement lamp soon
Source	Displays the name of the port to which the current input source is connected
Input Signal	Displays the input signal setting of the current input source
Resolution	Displays the resolution of the current input source
Video Signal	Displays the video signal format of the current input source

Information item	Description
Refresh Rate	Displays the refresh rate of the current input source
Sync Info	Displays information that may be needed by a service technician
Status	Displays information about projector problems that may be needed by a service technician
Serial Number	Displays the projector's serial number
Event ID	Displays the Event ID number corresponding to a specific projector problem; see the list of Event ID codes

[Event ID Code List](#)

Parent topic: [Adjusting the Menu Settings](#)

Event ID Code List

If the **Event ID** option on the Info menu displays a code number, check this list of Event ID codes for the solution to the projector problem associated with the code.

Event ID code	Cause and solution
0038	Wireless LAN system mismatch. Check the wireless LAN settings for the mobile device and projector, then try connecting again.
0042	
0041	Connection failed. Delete the recorded projector information on your computer and try connecting again.
0432	The network software did not start. Turn the projector off and then on again.
0435	
0433	Cannot display the transferred images. Restart the network software.
0434	Unstable network communication. Check the network communication status, wait a few moments, and try connecting to the network again.
0481	
0482	
0485	
0483	The network software quit unexpectedly. Check the network communication status, then turn the projector off and then on again.
04FE	

Event ID code	Cause and solution
0484	Communication with computer was disconnected. Restart the network software.
0479	A projector system error has occurred. Turn the projector off and then on again.
04FF	
0891	Cannot find an access point with the same SSID. Set your computer, access point, and projector to the same SSID.
0892	The WPA/WPA2 authentication type does not match. Make sure the wireless network security settings are correct.
0894	Communication with unauthorized access point was disconnected. Contact your network administrator.
0898	Failed to acquire DHCP address. Make sure the DHCP server is operating correctly. If you are not using DHCP, turn off the DHCP setting in the Network menus.
0899	A communication error has occurred.
089A	The EAP authentication type does not match the network. Check the wireless LAN security settings and make sure that the security certificate is installed correctly.
089B	EAP server authentication failed. Check the wireless LAN security settings and make sure that the security certificate is installed correctly.
089C	EAP client authentication failed. Check the wireless LAN security settings and make sure that the security certificate is installed correctly.
089D	Key exchange failed. Check the wireless LAN security settings and make sure that the security certificate is installed correctly.
0920	The internal battery that saves the projector's date and time settings is running low. Contact Epson for help.

Parent topic: [Projector Information Display - Info Menu](#)

Projector Reset Options - Reset Menu

You can reset most of the projector settings to their default values using the **Reset All Config** option on the Reset menu.

You can also reset the projector's lamp usage timer to zero when you replace the lamp using the **Reset Lamp Hours** option.

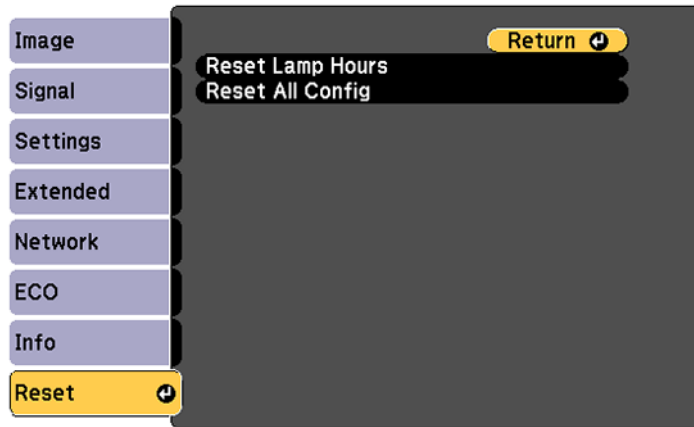

You cannot reset the following settings using the option:

- Input Signal
- User's Logo
- Schedule Settings
- Language
- Network menu items
- Lamp Hours
- Password
- Date & Time
- Display Background
- Startup Screen
- A/V Mute

Parent topic: [Adjusting the Menu Settings](#)

Maintaining and Transporting the Projector

Follow the instructions in these sections to maintain your projector and transport it from place to place.

[Projector Maintenance](#)

[Transporting the Projector](#)

Projector Maintenance

Your projector needs little maintenance to keep working at its best.

You may need to clean the lens periodically, and clean the air filter and air vents to prevent the projector from overheating due to blocked ventilation.

The only parts you should replace are the lamp, air filter, and remote control batteries. If any other part needs replacing, contact Epson or an authorized Epson servicer.

Warning: Before cleaning any part of the projector, turn it off and unplug the power cord. Never open any cover on the projector, except as specifically explained in this manual. Dangerous electrical voltages in the projector can injure you severely.

Warning: Do not try to service this product yourself, except as specifically explained in this manual. Refer all other servicing to qualified servicers.

[Cleaning the Lens](#)

[Cleaning the Projector Case](#)

[Air Filter and Vent Maintenance](#)

[Projector Lamp Maintenance](#)

[Replacing the Remote Control Batteries](#)

Parent topic: [Maintaining and Transporting the Projector](#)

Cleaning the Lens

Clean the projector's lens periodically, or whenever you notice dust or smudges on the surface.

- To remove dust or smudges, gently wipe the lens with lens-cleaning paper.

- To remove stubborn smudges, moisten a soft, lint-free cloth with lens cleaner and gently wipe the lens. Do not spray any liquid directly on the lens.

Warning: Do not use a lens cleaner that contains flammable gas. The high heat generated by the projector lamp may cause a fire.

Caution: Do not use glass cleaner or any harsh materials to clean the lens and do not subject the lens to any impacts; you may damage it. Do not use canned air, or the gases may leave a residue. Avoid touching the lens with your bare hands to prevent fingerprints on or damage to the lens surface.

Parent topic: [Projector Maintenance](#)

Cleaning the Projector Case

Before cleaning the projector case, turn off the projector and unplug the power cord.

- To remove dust or dirt, use a soft, dry, lint-free cloth.
- To remove stubborn dirt, use a soft cloth moistened with water and mild soap. Do not spray liquid directly on the projector.

Caution: Do not use wax, alcohol, benzene, paint thinner, or other chemicals to clean the projector case. These can damage the case. Do not use canned air, or the gases may leave a flammable residue.

Parent topic: [Projector Maintenance](#)

Air Filter and Vent Maintenance

Regular filter maintenance is important to maintaining your projector. Your Epson projector is designed with an easily accessible, user-replaceable filter to protect your projector and make regular maintenance simple. Filter maintenance intervals will depend on the environment.

If regular maintenance is not performed, your Epson projector will notify you when the temperature inside the projector has reached a high level. Do not wait until this warning appears to maintain your projector filter as prolonged exposure to high temperatures may reduce the life of your projector or lamp.

Damage due to the failure to properly maintain the projector or its filter may not be covered by the projector or lamp Limited Warranties.

[Cleaning the Air Filter and Vents](#)

[Replacing the Air Filter](#)

Parent topic: [Projector Maintenance](#)

Related references

[Projector Light Status](#)

Cleaning the Air Filter and Vents

Clean the projector's air filter or vents if they get dusty, or if you see a message telling you to clean them.

1. Turn off the projector and unplug the power cord.
2. Gently remove the dust using a small vacuum designed for computers or a very soft brush (such as a paintbrush).

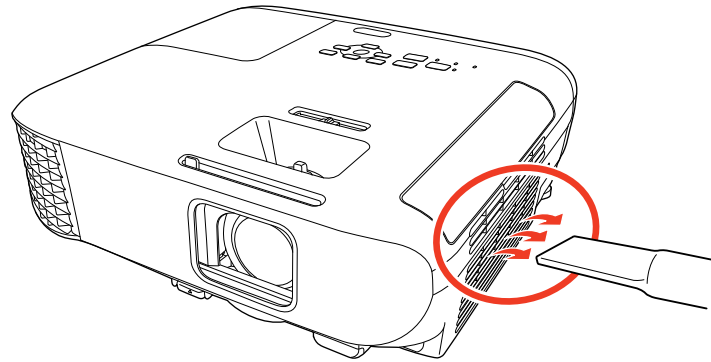

Note: You can remove the air filter so you can clean both sides of it. Do not rinse the air filter in water, or use any detergent or solvent to clean it.

Caution: Do not use canned air. The gases may leave a flammable residue or push dust and debris into the projector's optics or other sensitive areas.

3. If dust is difficult to remove or the air filter is damaged, replace the air filter.

Parent topic: [Air Filter and Vent Maintenance](#)

Replacing the Air Filter

You need to replace the air filter in the following situations:

- After cleaning the air filter, you see a message telling you to clean or replace it
- The air filter is torn or damaged

You can replace the air filter while the projector is mounted to the ceiling or placed on a table.

1. Turn off the projector and unplug the power cord.

2. Carefully open the air filter cover.

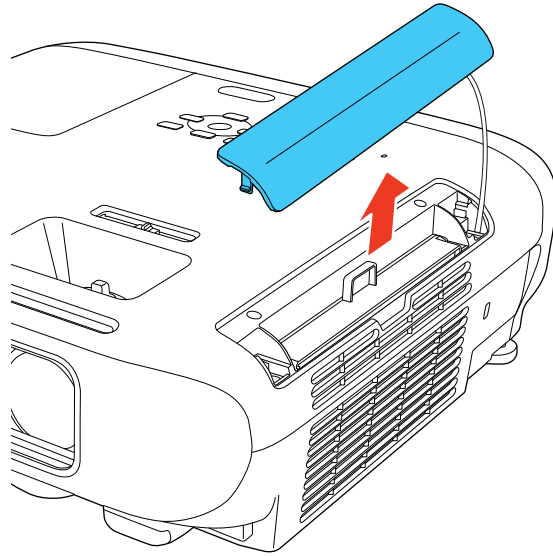

3. Pull the air filter out of the projector.

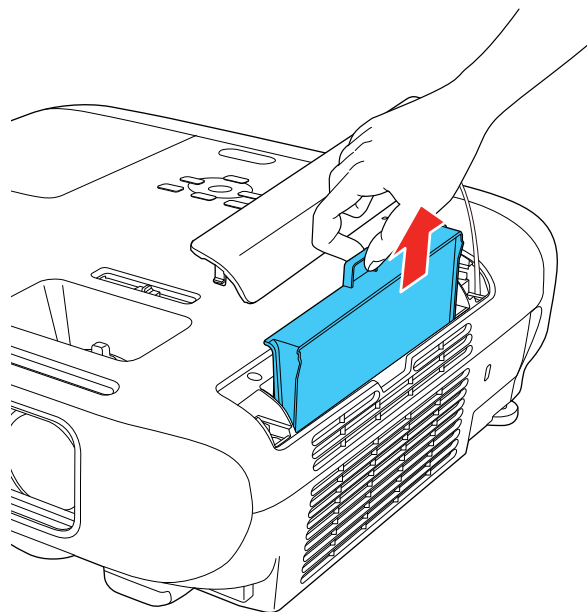

Note: Air filters contain ABS resin and polyurethane foam. Dispose of used air filters according to local regulations.

4. Place the new air filter in the projector as shown and push gently until it clicks into place.

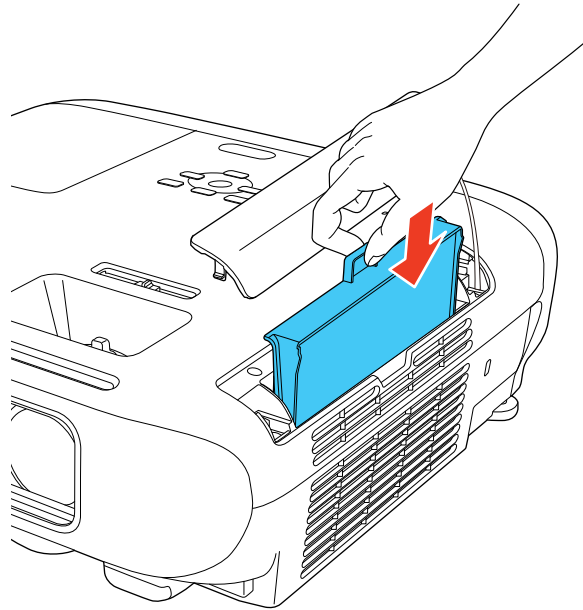

5. Close the air filter cover.

Parent topic: [Air Filter and Vent Maintenance](#)

Related references

[Optional Equipment and Replacement Parts](#)

Projector Lamp Maintenance

The projector keeps track of the number of hours the lamp is used and displays this information in the projector's menu system.

Replace the lamp as soon as possible when the following occurs:

- The projected image gets darker or starts to deteriorate
- A message appears when you turn on the projector telling you to replace the lamp
- The projector's Lamp light is flashing orange and its power light is flashing blue

[Replacing the Lamp](#)

[Resetting the Lamp Timer](#)

Parent topic: [Projector Maintenance](#)

Related references

[Projector Light Status](#)

[Projector Information Display - Info Menu](#)

Replacing the Lamp

Before you replace the lamp, let the projector cool down for at least one hour so the lamp will not be hot.

Warning: Let the lamp fully cool before replacing it to avoid injury.

You can replace the lamp while the projector is mounted to the ceiling, if necessary.

1. Turn off the projector and unplug the power cord.
2. Allow the projector lamp to cool down for at least one hour.
3. Use the screwdriver included with the replacement lamp to loosen the screw securing the lamp cover.

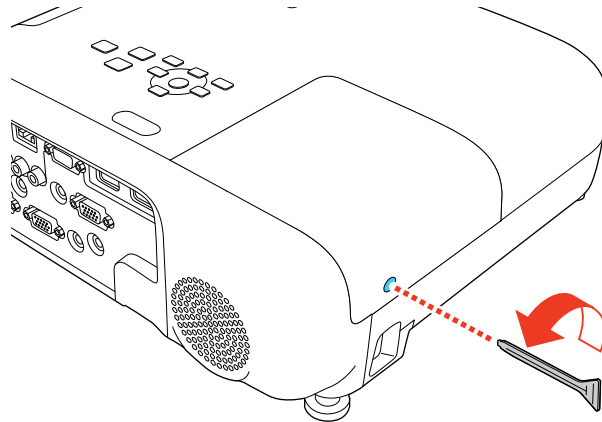

Warning: If the lamp is broken, glass fragments may be loose inside the lamp chamber. Be careful removing any broken glass to avoid injury. If the projector is installed on the ceiling, stand to the side of the lamp cover and not underneath it; pieces of glass could fall into your eyes or mouth when you open the lamp cover.

4. Slide the lamp cover out and lift it off.

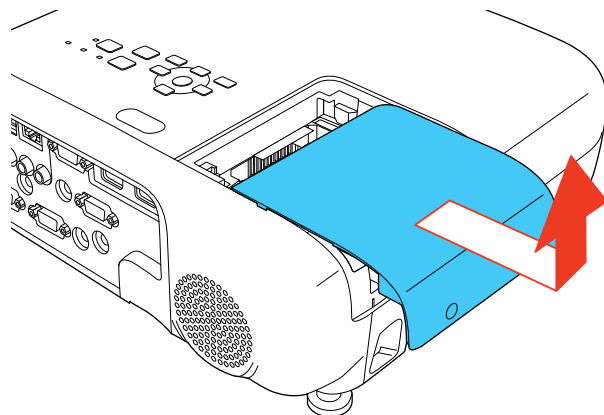

5. Loosen the screws securing the lamp to the projector. The screws do not come all the way out.

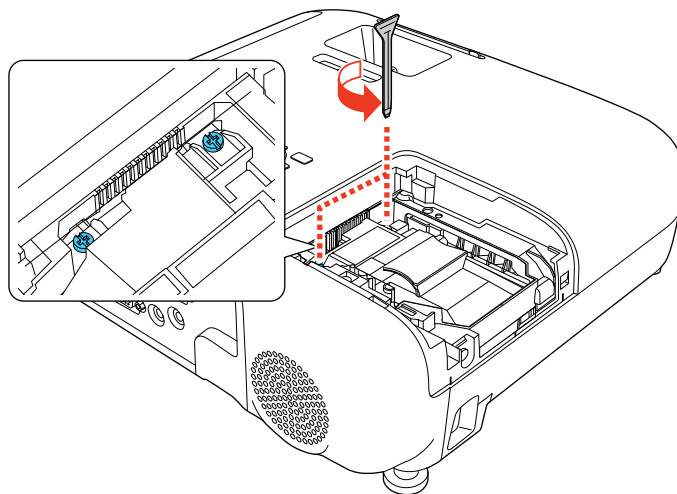

6. Grasp the raised section of the lamp and gently pull the lamp out of the projector.

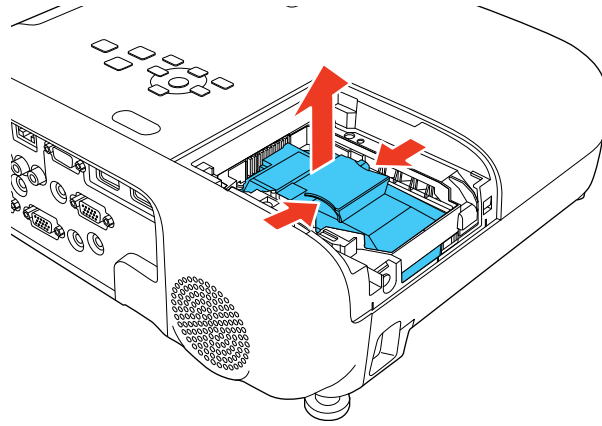

Note: (Hg) The lamp(s) in this product contain mercury. Please consult your state and local regulations regarding disposal or recycling. Do not put in the trash.

7. Gently insert the new lamp into the projector. If it does not fit easily, make sure it is facing the right way.

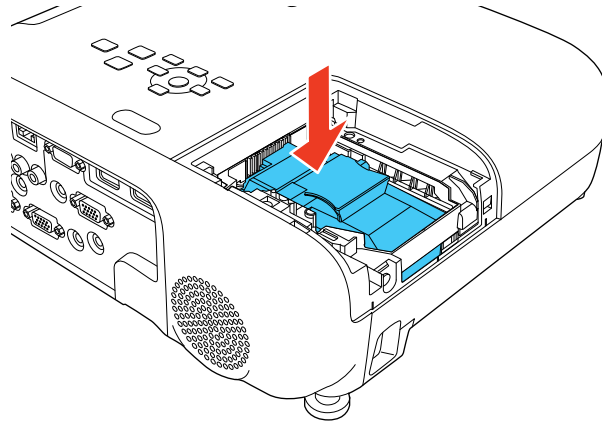

Caution: Do not touch any glass on the lamp assembly to avoid premature lamp failure.

8. Push in the lamp firmly and tighten the screws to secure it.

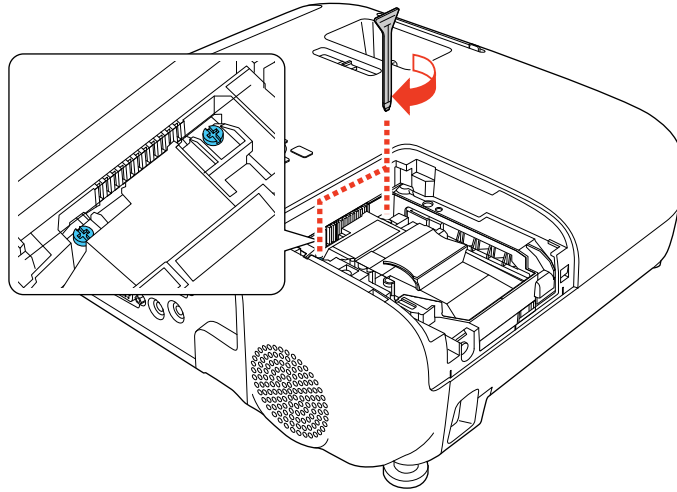

Caution: Do not over-tighten the screws.

9. Replace the lamp cover and tighten the screw to secure it.

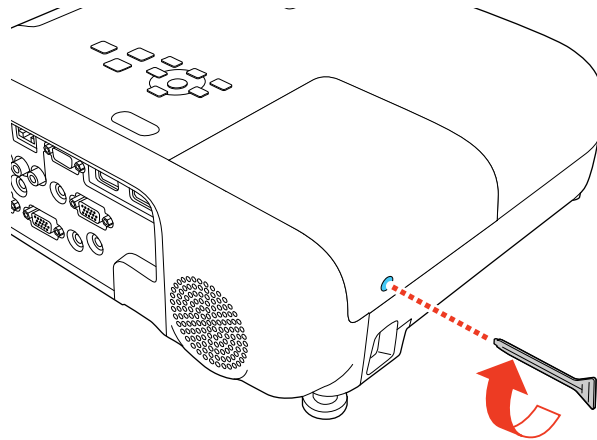

Note: Be sure the lamp cover is securely installed or the lamp will not come on.

Reset the lamp timer to zero to keep track of the new lamp's usage.

Parent topic: [Projector Lamp Maintenance](#)

Related references

[Optional Equipment and Replacement Parts](#)

Related tasks

[Resetting the Lamp Timer](#)

Resetting the Lamp Timer

You must reset the lamp timer after replacing the projector's lamp to clear the lamp replacement message and to keep track of lamp usage correctly.

Note: Do not reset the lamp timer if you have not replaced the lamp to avoid inaccurate lamp usage information.

1. Turn on the projector.
2. Press the **Menu** button.
3. Select the **Reset** menu and press **Enter**.

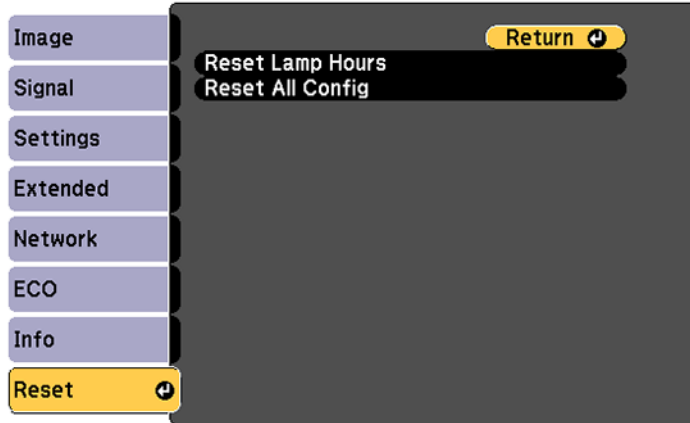

4. Select **Reset Lamp Hours** and press **Enter**.
You see a prompt asking if you want to reset the lamp hours.
5. Select **Yes** and press **Enter**.

6. Press **Menu** or **Esc** to exit the menus.

Parent topic: [Projector Lamp Maintenance](#)

Related tasks

[Replacing the Lamp](#)

Replacing the Remote Control Batteries

The remote control uses two AA manganese or alkaline batteries. Replace the batteries as soon as they run out.

Caution: Use only the type of batteries specified in this manual. Do not install batteries of different types, or mix new and old batteries.

1. Remove the battery cover as shown.

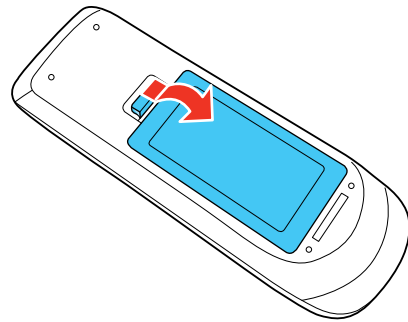

2. Remove the old batteries.

Warning: If the battery fluid has leaked, wipe it away with a soft cloth and avoid getting the fluid on your hands. If it gets on your hands, wash them immediately to avoid injury.

3. Insert the batteries with the + and – ends facing as shown.

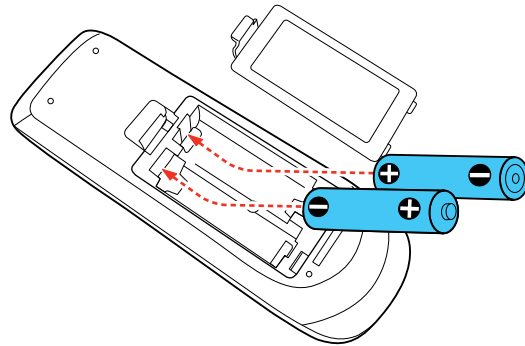

4. Replace the battery cover and press it down until it clicks into place.

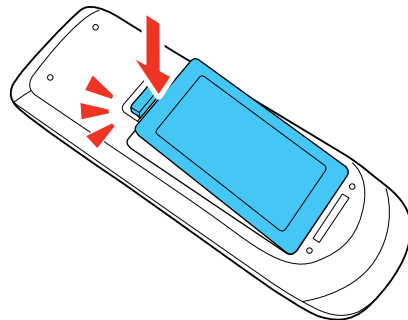

Warning: Dispose of used batteries according to local regulations. Do not expose batteries to heat or flame. Keep batteries out of the reach of children; they are choking hazards and are very dangerous if swallowed.

Parent topic: [Projector Maintenance](#)

Transporting the Projector

The projector contains precision parts, some of which are glass. Follow these guidelines to transport, ship, or store the projector safely:

- Close the lens cover to protect the lens.

- Remove any equipment connected to the projector.
- Use a carrying case to hand-carry the projector.
- When transporting the projector a long distance or as checked luggage, place it in a carrying case. Then pack the case in a firm box with cushioning around it and mark the box "Fragile."
- When shipping the projector for repairs, place it in its original packing materials, if possible, or use equivalent materials with cushioning around the projector. Mark the box "Fragile."

Note: Epson shall not be liable for any damages incurred during transportation.

Parent topic: [Maintaining and Transporting the Projector](#)

Solving Problems

Check the solutions in these sections if you have any problems using the projector.

[Projection Problem Tips](#)

[Projector Light Status](#)

[Using the Projector Help Displays](#)

[Solving Image or Sound Problems](#)

[Solving Projector or Remote Control Operation Problems](#)

[Solving Network Problems](#)

[Where to Get Help](#)

Projection Problem Tips

If the projector is not working properly, try turning it off and unplugging it. Then plug it back in and turn it on.

If this does not solve the problem, check the following:

- The lights on the projector may indicate what the problem is.
- The Help option on the Home screen can display information about common problems, if the projector is operating.
- The solutions in this manual can help you solve many problems.

If none of these solutions help, you can contact Epson for technical support.

Parent topic: [Solving Problems](#)

Related references

[Projector Light Status](#)

[Where to Get Help](#)

Related tasks

[Using the Projector Help Displays](#)

Projector Light Status

The lights on the projector indicate the projector status and let you know when a problem occurs. Check the status and color of the lights and look for a solution in the table here.

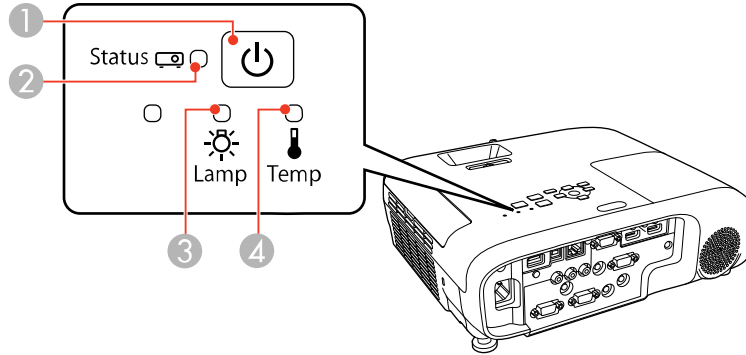

- 1 Power light
- 2 Status light
- 3 Lamp light
- 4 Temp (temperature) light

Projector status

Power light	Status light	Lamp light	Temp light	Status and solution
Blue	Blue	Off	Off	Normal operation
Blue	Flashing blue	Off	Off	Warming up or cooling down
Blue	Off	Off	Off	Standby or sleep mode
Flashing blue	Off	Off	Off	Preparing for network monitoring

Power light	Status light	Lamp light	Temp light	Status and solution
Flashing blue	Light status varies	Light status varies	Flashing orange	<p>Projector is too hot</p> <ul style="list-style-type: none"> • Make sure that the vents and air filter are not clogged with dust or obstructed by nearby objects • Clean or replace the air filter • Make sure the environmental temperature is not too hot
Off	Flashing blue	Off	Orange	<p>Projector has overheated and turned off; leave it turned off to cool down for about five minutes, then do the following:</p> <ul style="list-style-type: none"> • Make sure that the vents and air filter are not clogged with dust or obstructed by nearby objects • Clean or replace the air filter • If operating the projector at high altitude, turn on High Altitude Mode • If the problem persists, unplug the projector and contact Epson for help

Power light	Status light	Lamp light	Temp light	Status and solution
Off	Flashing blue	Orange	Off	Lamp or lamp cover has a problem <ul style="list-style-type: none"> • Check to see if the lamp is burned out, broken, or installed incorrectly; reseal or replace the lamp as necessary • Clean or replace the air filter • If operating the projector at high altitude, turn on High Altitude Mode • If the problem persists, unplug the projector and contact Epson for help • Check that the lamp cover is installed correctly
Flashing blue	Light status varies	Flashing orange	Light status varies	Replace the lamp soon to avoid damage; do not continue using the projector
Off	Flashing blue	Off	Flashing orange	A fan or sensor has a problem; turn the projector off, unplug it, and contact Epson for help
Off	Flashing blue	Flashing orange	Off	Internal projector error; turn the projector off, unplug it, and contact Epson for help
Off	Flashing blue	Flashing orange	Flashing orange	Auto iris error; turn the projector off, unplug it, and contact Epson for help
Off	Flashing blue	Orange	Orange	Power error; turn the projector off, unplug it, and contact Epson for help

Note: If the lights display a pattern not listed in the table above, turn the projector off, unplug it, and contact Epson for help.

Parent topic: [Solving Problems](#)

Related concepts

[Air Filter and Vent Maintenance](#)
[Projector Lamp Maintenance](#)

Related references

[Projector Setup Settings - Extended Menu](#)
[Where to Get Help](#)

Related tasks

[Turning Off the Projector](#)

Using the Projector Help Displays

You can display information to help you solve common problems using the projector's Help system.

1. Turn on the projector.
2. Press the **Home** button on the projector or the remote control.
3. Press the arrow buttons to select **Help**.
4. Press **Enter**.
You see the Help menu.
5. Press the up and down arrow buttons to highlight the problem you want to solve.
6. Press **Enter** to view the solutions.
7. When you are finished, do one of the following:
 - To select another problem to solve, press **Esc**.
 - To exit the help system, press **Home**.

Parent topic: [Solving Problems](#)

Solving Image or Sound Problems

Check the solutions in these sections if you have any problems with projected images or sound.

[Solutions When No Image Appears](#)
[Solutions When Image is Incorrect Using the USB Display Function](#)
[Solutions When "No Signal" Message Appears](#)
[Solutions When "Not Supported" Message Appears](#)
[Solutions When Only a Partial Image Appears](#)

[Solutions When the Image is Not Rectangular](#)

[Solutions When the Image Contains Noise or Static](#)

[Solutions When the Image is Fuzzy or Blurry](#)

[Solutions When the Image Brightness or Colors are Incorrect](#)

[Solutions to Sound Problems](#)

Parent topic: [Solving Problems](#)

Solutions When No Image Appears

If no image appears, try the following solutions:

- Make sure the lens cover is open all the way.
- Press the **A/V Mute** button on the remote control to see if the image was temporarily turned off.
- Make sure all necessary cables are securely connected and the power is on for the projector and connected video sources.
- Press the projector's power button to wake it from standby or sleep mode. Also see if your connected computer is in sleep mode or displaying a blank screen saver.
- Press the **Menu** button. If the projector menu is able to display, there may be a problem with the connected video source, cable connection, or port.
- Check the settings on the Signal menu to make sure they are correct for the current video source.
- Adjust the **Brightness** setting or select the **Normal** Power Consumption setting.
- Check the **Display** setting to make sure **Messages** is set to **On**.
- If the projector does not respond when you press the control panel buttons, the buttons may be locked. Unlock the buttons.
- If the projector does not respond when you press buttons on the remote control, make sure the remote receivers are turned on.
- For images projected with Windows Media Center, reduce the screen size from full screen mode.
- For images projected from applications using Windows DirectX, turn off DirectX functions.
- The projector may not be able to project copyrighted videos that you play back on a computer. For details, see the manual supplied with your computer.
- If the other solutions do not solve the problem, reset all of the projector settings using the options on the **Reset** menu.

Parent topic: [Solving Image or Sound Problems](#)

Related references

- [Image Quality Settings - Image Menu](#)
- [Input Signal Settings - Signal Menu](#)
- [Projector Setup Settings - Extended Menu](#)
- [Projector Reset Options - Reset Menu](#)

Related tasks

- [Unlocking the Projector's Buttons](#)

Solutions When Image is Incorrect Using the USB Display Function

If no image appears or if the image appears incorrectly using the USB Display function, try the following solutions:

- Press the **USB** button on the remote control.
- Make sure the USB Display software has installed correctly. Install it manually if necessary.
- On a Mac, select the **USB Display** icon in the Dock or from the **Applications** folder.
- For images projected with Windows Media Center, reduce the screen size from full screen mode.
- For images projected from applications using Windows DirectX, turn off DirectX functions.
- If the mouse cursor flickers, select **Make the movement of the mouse pointer smooth** in the Epson USB Display Settings program on your computer.
- Turn off the **Transfer layered window** setting in the Epson USB Display Settings program on your computer.
- If you are projecting using the 1080p video format and change the computer resolution during projection, the video quality and performance may decline.
- Make sure you are using the most recent version of the USB Display software. You can download the latest version from the Epson web site. Go to epson.com/support (U.S.) or epson.ca/support (Canada) and select your projector.

Parent topic: [Solving Image or Sound Problems](#)

Related tasks

- [Connecting to a Computer for USB Video and Audio](#)

Solutions When "No Signal" Message Appears

If the "No Signal" message appears, try the following solutions:

- Press the **Source Search** button and wait a few seconds for an image to appear.

- Press the **Home** button on the remote control to select from a list of available sources (shown in black text).
- Turn on the connected computer or video source, and press its play button to begin your presentation, if necessary.
- Check the connection from the projector to your video sources.
- If you are projecting from a laptop computer, make sure it is set up to display on an external monitor.
- If necessary, turn the projector and the connected computer or video source off and then on again.
- If you are projecting from an HDMI source, replace the HDMI cable with a shorter one.
- If the other solutions do not solve the problem, reset all of the projector settings using the options on the **Reset** menu.

[Displaying From a PC Laptop](#)

[Displaying From a Mac Laptop](#)

Parent topic: [Solving Image or Sound Problems](#)

Related references

[Projector Reset Options - Reset Menu](#)

Related tasks

[Selecting an Image Source](#)

Displaying From a PC Laptop

If you see the "No Signal" message when you display from a PC laptop, you need to set up the laptop to display on an external monitor.

1. Hold down the laptop's **Fn** key and press the key labeled with a monitor icon or **CRT/LCD**. (See your laptop manual for details.) Wait a few seconds for an image to appear. To display on both the laptop's monitor and the projector, try pressing the same keys again.

Note: On Windows 7 or later, hold down the Windows key and press **P** at the same time, then click **Duplicate**.

2. If the same image is not displayed by the laptop and projector, check the Windows **Display** utility to make sure the external monitor port is enabled and extended desktop mode is disabled. (See your computer or Windows manual for instructions.)
3. If necessary, check your video card settings and set the multiple display option to **Clone**, **Mirror**, or **Duplicate**.

Parent topic: [Solutions When "No Signal" Message Appears](#)

Displaying From a Mac Laptop

If you see the "No Signal" message when you display from a Mac laptop, you need to set up the laptop for mirrored display. (See your laptop manual for details.)

1. Open the **System Preferences** utility and select **Displays**, **Display**, or **Color LCD**.
2. Click the **Arrange** or **Arrangement** tab.
3. Select the **Mirror Displays** checkbox.

Parent topic: [Solutions When "No Signal" Message Appears](#)

Solutions When "Not Supported" Message Appears

If the "Not Supported" message appears, try the following solutions:

- Make sure the correct input signal is selected on the Signal menu.
- Make sure the computer's display resolution does not exceed the projector's resolution and frequency limit. If necessary, select a different display resolution for your computer. (See your computer manual for details.)
- As a test, try setting the computer's display resolution to the lowest possible setting, and then gradually increase it as necessary.

Parent topic: [Solving Image or Sound Problems](#)

Related references

[Input Signal Settings - Signal Menu](#)

[Supported Video Display Formats](#)

Solutions When Only a Partial Image Appears

If only a partial computer image appears, try the following solutions:

- Press the **Auto** button on the remote control to optimize the image signal.
- Make sure the **Resolution** setting in the Signal menu is set correctly for the input signal.
- Try adjusting the image position using the **Position** menu setting.
- Press the **Aspect** button on the remote control to select a different image aspect ratio.
- If you zoomed into or out of the image using the **E-Zoom** buttons, press the **Esc** button until the projector returns to a full display.
- Check the cables connecting the computer or video source to the projector. Try connecting different cables.

- Check your computer display settings to disable dual display and set the resolution within the projector's limits. (See your computer manual for details.)
- Check the resolution assigned to your presentation files to see if they are created for a different resolution than you are projecting in. (See your software help for details.)
- Make sure you selected the correct **Projection** setting.

Parent topic: [Solving Image or Sound Problems](#)

Related references

[Input Signal Settings - Signal Menu](#)

[Supported Video Display Formats](#)

Solutions When the Image is Not Rectangular

If the projected image is not evenly rectangular, try the following solutions:

- Turn on automatic keystone adjustments using the projector's menus.
- Place the projector directly in front of the center of the screen, facing it squarely, if possible.
- If you adjusted the projector height using the projector feet, press the keystone buttons on the projector to adjust the image shape.
- Adjust the position of the projector's horizontal keystone slider.
- Adjust the **Quick Corner** setting to correct the image shape.

Parent topic: [Solving Image or Sound Problems](#)

Related concepts

[Image Shape](#)

Related references

[Projector Feature Settings - Settings Menu](#)

Solutions When the Image Contains Noise or Static

If the projected image seems to contain electronic interference (noise) or static, try the following solutions:

- Check the cables connecting your computer or video source to the projector. They should be:
 - Separated from the power cord to prevent interference
 - Securely connected at both ends
 - Not connected to an extension cable

- No longer than 10 feet (3 m) for VGA/computer cables or 24 feet (7.3 m) for HDMI cables
- Check the settings on the projector's Signal menu to make sure they match the video source. If available for your video source, adjust the **Deinterlacing** and **Noise Reduction** settings.
- If available for your video source, select **Auto** as the Resolution setting in the Signal menu.
- Select a computer video resolution and refresh rate that are compatible with the projector.
- If you are projecting from a computer, press the **Auto** button on the remote control to automatically adjust the tracking and sync. If the problem remains, display a uniformly patterned image on the screen and manually adjust the **Tracking** and **Sync** settings.
- If you connected an extension power cable, try projecting without it to see if it caused interference in the signal.
- If you are using the USB Display function, turn off the **Transfer layered window** setting in the Epson USB Display Settings program on your computer.
- Try a different cable.

Parent topic: [Solving Image or Sound Problems](#)

Related references

[Image Quality Settings - Image Menu](#)

[Input Signal Settings - Signal Menu](#)

[Supported Video Display Formats](#)

Solutions When the Image is Fuzzy or Blurry

If the projected image is fuzzy or blurry, try the following solutions:

- Adjust the image focus.
- Clean the projector lens.

Note: To avoid condensation on the lens after bringing the projector in from a cold environment, let the projector warm up to room temperature before using it.

- Position the projector close enough to the screen.
- Position the projector so the keystone adjustment angle is not so wide that it distorts the image.
- Turn on automatic keystone adjustment in the projector's menus.
- Adjust the **Sharpness** setting to improve image quality.

- If you are projecting from a computer, press the **Auto** button on the remote control to automatically adjust the tracking and sync. If any bands or overall blurriness remain, display a uniformly patterned image on the screen and manually adjust the **Tracking** and **Sync** settings.
- If you are projecting from a computer, try using a lower resolution or try to match the projector's native resolution.

Parent topic: [Solving Image or Sound Problems](#)

Related concepts

[Projector Placement](#)

Related references

[Image Quality Settings - Image Menu](#)

[General Projector Specifications](#)

Related tasks

[Focusing the Image Using the Focus Ring](#)

[Cleaning the Lens](#)

Solutions When the Image Brightness or Colors are Incorrect

If the projected image is too dark or light, or the colors are incorrect, try the following solutions:

- Press the **Color Mode** button on the remote control to try different color modes for the image and environment.
- Check your video source settings.
- Adjust the available settings on the Image menu for the current input source, such as **Brightness**, **Contrast**, **Tint**, **Color Temp.**, and/or **Color Saturation**.
- Make sure you selected the correct **Input Signal** or **Video Signal** setting on the Signal menu, if available for your image source.
- Make sure all the cables are securely connected to the projector and your video device. If you connected long cables, try connecting shorter cables.
- Position the projector close enough to the screen.
- If the image has been progressively darkening, you may need to replace the projector lamp soon.

Parent topic: [Solving Image or Sound Problems](#)

Related concepts

[Color Mode](#)

[Projector Placement](#)

Related references

[Image Quality Settings - Image Menu](#)

[Input Signal Settings - Signal Menu](#)

[Projector Setup Settings - ECO Menu](#)

Solutions to Sound Problems

If there is no sound when you expect it or the volume is too low or high, try the following solutions:

- Adjust the projector's volume settings.
- Press the **A/V Mute** button on the remote control to resume video and audio if they were temporarily stopped.
- Check your computer or video source to make sure the volume is turned up and the audio output is set for the correct source.
- Try disconnecting and reconnecting the audio cable.
- Check the audio cable connections between the projector and your video source.
- If you do not hear sound from an HDMI source, set the connected device to PCM output.
- Make sure any connected audio cables are labeled "No Resistance".
- If you are using the USB Display function, turn on the **Output audio from the projector** setting in the Epson USB Display Settings program on your computer.
- If you are using a Mac and you do not hear sound from an HDMI source, make sure your Mac supports audio through the HDMI port. If not, you need to connect an audio cable.
- If the volume for the computer is set to the minimum while the projector's volume is set to maximum, the noise may be mixed. Turn up the computer's volume and decrease the projector's volume.
- If you turn the projector on immediately after turning it off, the cooling fans may run at high speed momentarily and cause an unexpected noise. This is normal.

Parent topic: [Solving Image or Sound Problems](#)

Related references

[Projector Setup Settings - ECO Menu](#)

[Projector Setup Settings - Extended Menu](#)

Solving Projector or Remote Control Operation Problems

Check the solutions in these sections if you have problems operating the projector or remote control.

[Solutions to Projector Power or Shut-Off Problems](#)

[Solutions to Problems with the Remote Control](#)

[Solutions to Password Problems](#)

Parent topic: [Solving Problems](#)

Solutions to Projector Power or Shut-Off Problems

If the projector does not come on when you press the power button or it shuts off unexpectedly, try the following solutions:

- Make sure the power cord is securely connected to the projector and to a working electrical outlet.
- The projector's buttons may be locked for security. Unlock the buttons or use the remote control to turn on the projector.
- If the projector's lamp shuts off unexpectedly, it may have entered standby mode after a period of inactivity. Press the power button to wake the projector and adjust the **Sleep Mode Timer** setting to change the sleep interval.
- If the power button on the remote control does not turn on the projector, check its batteries and make sure the **Remote Receiver** setting is turned on in the projector's menu, if available.
- The power cord may be defective. Try another power cord. If that doesn't work, disconnect the cord and contact Epson.

Parent topic: [Solving Projector or Remote Control Operation Problems](#)

Related references

[Projector Light Status](#)

[Projector Feature Settings - Settings Menu](#)

[Projector Setup Settings - ECO Menu](#)

Related tasks

[Unlocking the Projector's Buttons](#)

Solutions to Problems with the Remote Control

If the projector does not respond to remote control commands, try the following solutions:

- Check that the remote control batteries are installed correctly and have power. If necessary, replace the batteries.
- Make sure you are operating the remote control within the reception angle and range of the projector.
- Make sure the projector is not warming up or shutting down.

- Check to see if a button on the remote control is stuck down, causing it to enter sleep mode. Release the button to wake the remote control up.
- Strong fluorescent lighting, direct sunlight, or infrared device signals may be interfering with the projector's remote receivers. Dim the lights or move the projector away from the sun or interfering equipment.
- If available, turn on one of the remote receivers in the projector's menu system, or check if all the remote receivers were turned off.
- If you assigned an ID number to the remote control to operate multiple projectors, you may need to check or change the ID setting (feature not available with all projectors).
- If you lose the remote control, you can purchase another from an authorized Epson reseller.

Parent topic: [Solving Projector or Remote Control Operation Problems](#)

Related references

[Remote Control Operation](#)

[Projector Feature Settings - Settings Menu](#)

Related tasks

[Replacing the Remote Control Batteries](#)

Solutions to Password Problems

If you cannot enter or remember a password, try the following solutions:

- You may have turned on password protection without first setting a password. Try entering **0000** using the remote control.
- If you have entered an incorrect password too many times and see a message displaying a request code, write down the code and contact Epson. Do not attempt to enter the password again. Provide the request code and proof of ownership for assistance in unlocking the projector.
- If you set a Epson Web Control password and forgot the user ID or password, try entering the following:
 - User ID: **EPSONWEB**
 - Default password: **admin**
- If you set a Remote password (in Epson Web Control) and forgot the user ID or password, try entering the following:
 - User ID: **EPSONREMOTE**
 - Default password: **guest**

- If you lose the remote control, you cannot enter a password. Order a new one from Epson.

Parent topic: [Solving Projector or Remote Control Operation Problems](#)

Related concepts

[Password Security Types](#)

Solving Network Problems

Check the solutions in these sections if you have problems using the projector on a network.

[Solutions When Wireless Authentication Fails](#)

[Solutions When You Cannot Access the Projector Through the Web](#)

[Solutions When the Image Contains Static During Network Projection](#)

[Solutions When Network Alert E-Mails are Not Received](#)

Parent topic: [Solving Problems](#)

Solutions When Wireless Authentication Fails

If you cannot authenticate a wireless connection, try the following solutions:

- Make sure the **Wireless Mode** setting is set to **Wireless Lan On**.
- Check the Security settings and passphrase in the Network Configuration menu.
- Check the Event ID number displayed in the Info menu and check the link below to identify the problem.

Parent topic: [Solving Network Problems](#)

Related references

[Projector Network Settings - Network Menu](#)

Related tasks

[Selecting Wireless Network Settings Manually](#)

Solutions When You Cannot Access the Projector Through the Web

If you are unable to access the projector through a web browser, make sure you are using the correct ID and password, which are case sensitive.

Note: You cannot change the user ID.

- You may need to log in to access some options on the Web Control screen. If you see a log in window, enter **EPSONWEB** as the user ID and enter the password set in the projector's Network menu as the password. The default password is **admin**.
- To display the Web Remote screen, enter **EPSONREMOTE** as the user ID and enter the password set in the projector's Network menu as the password. The default password is **guest**.
- Make sure you have access to the network the projector is on.

Note: The user ID and password are case sensitive.

Parent topic: [Solving Network Problems](#)

Solutions When the Image Contains Static During Network Projection

If the projected image contains static during network projection, try the following solutions:

- Check for any obstacles between the access point, the computer, the mobile device, and the projector. If necessary, change their positions to improve communication. Also, make sure that they are not too far apart. Move them closer together and try to connect again.
- If the wireless connection is slow or your projected image contains noise, check for interference from other equipment, such as a Bluetooth device or microwave. Move the interfering device farther away or expand your wireless bandwidth.
- If the connection speed declines, reduce the number of connected devices.

Parent topic: [Solving Network Problems](#)

Solutions When Network Alert E-Mails are Not Received

If you do not receive an e-mail alerting you to problems with a projector over the network, try the following solutions:

- Make sure the projector is turned on and connected to the network correctly. (If an error shut down the projector, it cannot send an e-mail.)
- Make sure you set up the projector e-mail alert settings correctly on the projector's network menu or in the network software.
- Set the **Standby Mode** setting to **Communication On** so the network software can monitor the projector in standby mode. Change the **Port** setting according to your network environment.

Parent topic: [Solving Network Problems](#)

Related references

[Projector Setup Settings - ECO Menu](#)

Related tasks

[Setting Up Projector Network E-Mail Alerts](#)

Where to Get Help

If you need to contact Epson for technical support services, use the following support options.

Internet Support

Visit Epson's support website at epson.com/support (U.S.), epson.ca/support (Canada), or epson.com.jm/support (Caribbean) and select your product for solutions to common problems with your projector. You can download utilities and documentation, get FAQs and troubleshooting advice, or e-mail Epson with your questions.

Speak to a Support Representative

To use the Epson PrivateLine Support service, call (800) 637-7661. This service is available for the duration of your warranty period. You may also speak with a projector support specialist by dialing (562) 276-4394 (U.S.) or (905) 709-3839 (Canada).

Support hours are 6 AM to 8 PM, Pacific Time, Monday through Friday and 7 AM to 4 PM, Pacific Time, Saturday.

Days and hours of support are subject to change without notice. Toll or long distance charges may apply.

Before you call, have the following information ready:

- Product name
- Product serial number (located on the bottom or rear of the projector, or in the menu system)
- Proof of purchase (such as a store receipt) and date of purchase
- Computer or video configuration
- Description of the problem

Purchase Supplies and Accessories

You can purchase screens, other optional accessories, and replacement parts from an Epson authorized reseller. To find the nearest reseller, call 800-GO-EPSON (800-463-7766) in the U.S. or 800-807-7766 in Canada. Or you can purchase online at epsonstore.com (U.S. sales) or epsonstore.ca (Canadian sales).

To purchase a replacement remote control, call (562) 276-4394 (U.S.) or (905) 709-3839 (for dealer referral in Canada).

Parent topic: [Solving Problems](#)

Technical Specifications

These sections list the technical specifications of your projector.

[General Projector Specifications](#)

[Projector Lamp Specifications](#)

[Remote Control Specifications](#)

[Projector Dimension Specifications](#)

[Projector Electrical Specifications](#)

[Projector Environmental Specifications](#)

[Projector Safety and Approvals Specifications](#)

[Supported Video Display Formats](#)

[USB Display System Requirements](#)

General Projector Specifications

Type of display

Poly-silicon TFT active matrix

Resolution

PowerLite 107/108/970:

1024 × 768 pixels (XGA)

PowerLite 109W/980W:

1280 × 800 pixels (WXGA)

PowerLite 990U:

1920 × 1200 pixels (WUXGA)

Lens

PowerLite 107/108/109W:

F=1.49 to 1.72

PowerLite 970/980W:

F=1.51 to 1.99

PowerLite 990U:

F=1.50 to 1.90

PowerLite 107/108/109W:

Focal length: 16.9 to 20.28 mm

PowerLite 970/980W:

Focal length: 18.2 to 29.2 mm

PowerLite 990U:

Focal length: 20.3 to 32.5 mm

Color reproduction

Full color, up to 1 billion colors

Brightness

PowerLite 107:

Normal Power Consumption mode:

White light output 3500 lumens (ISO 21118 standard)

Color light output 3500 lumens

ECO Power Consumption mode:

White light output 2230 lumens (ISO 21118 standard)

Note: Color brightness (color light output) and white brightness (white light output) will vary depending on usage conditions. Color light output measured in accordance with IDMS 15.4; white light output measured in accordance with ISO 21118.

PowerLite 108:

Normal Power Consumption mode:

White light output 3700 lumens (ISO 21118 standard)

Color light output 3700 lumens

ECO Power Consumption mode:

White light output 2340 lumens (ISO 21118 standard)

Note: Color brightness (color light output) and white brightness (white light output) will vary depending on usage conditions. Color light output measured in accordance with IDMS 15.4; white light output measured in accordance with ISO 21118.

PowerLite 109W:

Normal Power Consumption mode:

White light output 4000 lumens (ISO 21118 standard)

Color light output 4000 lumens

ECO Power Consumption mode:

White light output 2490 lumens (ISO 21118 standard)

Note: Color brightness (color light output) and white brightness (white light output) will vary depending on usage conditions. Color light output measured in accordance with IDMS 15.4; white light output measured in accordance with ISO 21118.

PowerLite 970:

Normal Power Consumption mode:

White light output 4000 lumens (ISO 21118 standard)

Color light output 4000 lumens

ECO Power Consumption mode:

White light output 2500 lumens (ISO 21118 standard)

Note: Color brightness (color light output) and white brightness (white light output) will vary depending on usage conditions. Color light output measured in accordance with IDMS 15.4; white light output measured in accordance with ISO 21118.

PowerLite 980W:

Normal Power Consumption mode:

White light output 3800 lumens (ISO 21118 standard)

Color light output 3800 lumens

ECO Power Consumption mode:

White light output 2410 lumens (ISO 21118 standard)

Note: Color brightness (color light output) and white brightness (white light output) will vary depending on usage conditions. Color light output measured in accordance with IDMS 15.4; white light output measured in accordance with ISO 21118.

PowerLite 990U:

Normal Power Consumption mode:

White light output 3800 lumens (ISO 21118 standard)

Color light output 3800 lumens

ECO Power Consumption mode:

White light output 2410 lumens (ISO 21118 standard)

Note: Color brightness (color light output) and white brightness (white light output) will vary depending on usage conditions. Color light output measured in accordance with IDMS 15.4; white light output measured in accordance with ISO 21118.

Contrast ratio

15000:1 with Auto Iris on, Dynamic Color Mode, Zoom Wide, and Normal Power Consumption mode

Image size

(in native aspect ratio)

PowerLite 107/108/970/990U:

30 inches (0.76 m) to 300 inches (7.62 m)

PowerLite 109W:

33 inches (0.84 m) to 320 inches (8.13 m)

PowerLite 980W:

29 inches (0.74 m) to 280 inches (7.11 m)

Projection distance

(in native aspect ratio)

PowerLite 107/108:

35 inches (0.89 m) to 431 inches (10.95 m)

PowerLite 109W:

35.8 inches (0.91 m) to 429 inches (10.89 m)

PowerLite 970:

32.7 inches (0.83 m) to 546 inches (13.86 m)

PowerLite 980W:

33.5 inches (0.85 m) to 540 inches (13.71 m)

PowerLite 990U:

34.6 inches (0.88 m) to 574 inches (14.57 m)

Projection methods	Front, rear, ceiling-mounted
Optical aspect ratio (width-to-height)	PowerLite 107/108/970: 4:3 PowerLite 109W/980W/990U: 16:10
Focus adjustment	Manual
Zoom adjustment	Manual
Zoom ratio (Tele-to-Wide)	PowerLite 107/108/109W: 1 to 1.2 PowerLite 970/980W/990U: 1 to 1.6
Internal sound system	16 W monaural
Noise level	37 dB (Normal Power Consumption mode) 28 dB (ECO Power Consumption mode)
Keystone correction angle	± 30° vertical (manual or Auto Keystone) ± 30° horizontal (manual)
USB Type B port compatibility	USB 1.1 and 2.0 compliant for USB display, external mouse or keyboard control, or firmware update
USB Type A port compatibility	One USB 1.1 and 2.0 compliant port for USB device input, Epson document camera display, wireless LAN module, or firmware update

Parent topic: [Technical Specifications](#)

Projector Lamp Specifications

Type	UHE (Ultra High Efficiency)
Power consumption	210 W

Lamp life	Normal Power Consumption mode:
	Up to about 6000 hours
	ECO Power Consumption mode:
	Up to about 12000 hours

Note: Turn off this product when not in use to prolong the life of the projector. Lamp life will vary depending upon mode selected, environmental conditions, and usage. Brightness decreases over time.

Parent topic: [Technical Specifications](#)

Remote Control Specifications

Reception range	19.7 feet (6 m)
Batteries	Two alkaline or manganese AA

Parent topic: [Technical Specifications](#)

Projector Dimension Specifications

Height (excluding feet)	PowerLite 107/108/109W: 3.4 inches (87 mm)
	PowerLite 970/980W/990U: 3.5 inches (90 mm)
Width	PowerLite 107/108/109W: 11.9 inches (302 mm)
	PowerLite 970/980W/990U: 12.2 inches (309 mm)
Depth	PowerLite 107/108/109W: 9.8 inches (249 mm)
	PowerLite 970/980W/990U: 11.1 inches (282 mm)

Weight**PowerLite 107/108/109W:**

6.39 lb (2.9 kg)

PowerLite 970/980W:

6.83 lb (3.1 kg)

PowerLite 990U:

7.05 lb (3.2 kg)

Parent topic: [Technical Specifications](#)

Projector Electrical Specifications

Rated frequency

50/60 Hz

Power supply100 to 240 V AC \pm 10%

2.9 to 1.3 A

Power consumption

(100 to 120 V)

Operating:

Normal Power Consumption mode: 325 W

ECO Power Consumption mode: 230 W

Standby:

0.2 W (Communication Off), 2.0 W (Communication On)

Power consumption

(220 to 240 V)

Operating:

Normal Power Consumption mode: 315 W

ECO Power Consumption mode: 225 W

Standby:

0.2 W (Communication Off), 2.0 W (Communication On)

Parent topic: [Technical Specifications](#)

Projector Environmental Specifications

Temperature	Operating: Up to 7500 feet (2286 m): 41 to 95 °F (5 to 35 °C) 7500 feet (2286 m) to 9843 feet (3000 m): 41 to 86 °F (5 to 30 °C) Storage: 14 to 140 °F (–10 to 60 °C)
Humidity (relative, non-condensing)	Operating: 20 to 80% Storage: 10 to 90%
Operating altitude	Up to 4921 feet (1500 m) Up to 9843 feet (3000 m) with High Altitude Mode enabled

Parent topic: [Technical Specifications](#)

Projector Safety and Approvals Specifications

United States	FCC Part 15 Class B (DoC) UL60950-1 2nd edition / UL62368-2 2nd edition (cTUVus Mark)
Canada	ICES-003 Class B CSA C22.2 No. 60950-1-07 / CSA C22.2 No. 62368-1-14 (cTUVus Mark)

Parent topic: [Technical Specifications](#)

Supported Video Display Formats

For best results, your computer's monitor port or video card resolution should be set to display in the projector's native resolution. However, your projector includes Epson's SizeWise chip that supports other computer display resolutions, so your image will be resized to fit automatically.

Your computer's monitor port or video card refresh rate (vertical frequency) must be compatible with the projector. (See your computer or video card manual for details.)

The table here lists the compatible refresh rate and resolution for each compatible video display format.

Display format	Refresh rate (in Hz)	Resolution (in pixels)
Computer signals (analog RGB)		
VGA	60/72/75/85	640 × 480
SVGA	60/72/75/85	800 × 600
XGA	60/72/75/85	1024 × 768
WXGA	60	1280 × 768
	60	1366 × 768
	60/75/85	1280 × 800
WXGA+	60/75/85	1440 × 900
WXGA++	60	1600 × 900
SXGA	70/75/85	1152 × 864
	60/75/85	1280 × 1024
	60/75/85	1280 × 960
SXGA+	60/75	1400 × 1050
WSXGA+ ¹	60	1680 × 1050
UXGA	60	1600 × 1200
WUXGA (Reduced Blanking) ²	60	1920 × 1200
Component video		
SDTV (480i/480p)	60	720 × 480
SDTV (576i/576p)	50	720 × 576
HDTV (720p)	50/60	1280 × 720
HDTV (1080i/1080p)	50/60	1920 × 1080
Composite video		
TV (NTSC)	60	720 × 480
TV (SECAM)	50	720 × 576
TV (PAL)	50/60	720 × 576
HDMI input signals		

Display format	Refresh rate (in Hz)	Resolution (in pixels)
VGA	60	640 × 480
SVGA	60	800 × 600
XGA	60	1024 × 768
WXGA	60	1280 × 800
	60	1366 × 768
WXGA+	60	1440 × 900
WXGA++	60	1600 × 900
SXGA	60	1280 × 960
	60	1280 × 1024
SXGA+	60	1400 × 1050
WSXGA+ ³	60	1680 × 1050
UXGA	60	1600 × 1200
WUXGA(Reduced Blanking) ⁴	60	1920 × 1200
SDTV (480i/480p)	60	720 × 480
SDTV (576i/576p)	50	720 × 576
HDTV (720p)	50/60	1280 × 720
HDTV (1080i)	50/60	1920 × 1080
HDTV (1080p)	24/30/50/60	1920 × 1080
MHL input signals		
VGA	60	640 × 480
SDTV (480i/480p)	60	720 × 480
SDTV (576i/576p)	50	720 × 576
HDTV (720p)	50/60	1280 × 720
HDTV (1080i)	50/60	1920 × 1080
HDTV (1080p)	24/30	1920 × 1080

¹ **Wide** resolution only for PowerLite 109W/980W/990U

² PowerLite 990U only

³ PowerLite 109W/980W/990U only

⁴ PowerLite 990U only

Parent topic: [Technical Specifications](#)

USB Display System Requirements

Your computer system must meet the system requirements here to use the projector's USB Display software.

Requirement	Windows	Mac
Operating system	Windows Vista Ultimate, Enterprise, Business, Home Premium, and Home Basic (32-bit)	OS X 10.7.x (32- and 64-bit), 10.8.x (64-bit), 10.9.x (64-bit), 10.10.x (64-bit), 10.11.x (64-bit)
	Windows 7 Ultimate, Enterprise, Professional, and Home Premium (32- and 64-bit); Home Basic and Starter (32-bit)	macOS 10.12.x (64-bit)
	Windows 8.x, Pro, and Enterprise (32- and 64-bit)	
	Windows 10 Home, Pro, and Enterprise (32- and 64-bit)	
CPU	Intel Core2 Duo or faster (Intel Core i3 or faster recommended)	Intel Core2 Duo or faster (Intel Core i5 or faster recommended)
Memory	2GB or more (4GB or more recommended)	
Hard disk space	20MB or more	
Display	Resolution between 640 × 480 and 1920 × 1200, 16-bit color or greater	

Note: USB Display operation is not guaranteed for Windows Vista without service packs or with Service Pack 1.

Parent topic: [Technical Specifications](#)

Notices

Check these sections for important notices about your projector.

[Recycling](#)

[Important Safety Information](#)

[Important Safety Instructions](#)

[List of Safety Symbols \(corresponding to IEC60950-1 A2\)](#)

[FCC Compliance Statement](#)

[Binding Arbitration and Class Waiver](#)

[Trademarks](#)

[Copyright Notice](#)

Recycling

Epson offers a recycling program for end of life products. Please go to [this site](#) for information on how to return your products for proper disposal.

Parent topic: [Notices](#)

Important Safety Information

Caution: Never look into the projector lens when the lamp is turned on; the bright light can damage your eyes. Never let children look into the lens when it is on. Never open any cover on the projector, except the lamp and filter covers. Dangerous electrical voltages inside the projector can severely injure you. Except as specifically explained in this *User's Guide*, do not attempt to service this product yourself. Refer all servicing to qualified service personnel.

Warning: The projector and its accessories come packaged in plastic bags. Keep plastic bags away from small children to avoid any risk of suffocation.

Caution: When you replace the lamp, never touch the new lamp with your bare hands; the invisible residue left by the oil on your hands may shorten the lamp life. Use a cloth or glove to handle the new lamp.

Parent topic: [Notices](#)

Important Safety Instructions

Follow these safety instructions when setting up and using the projector:

- Do not look into the lens when the projector is on. The bright light can damage your eyes. Avoid standing in front of the projector so the bright light does not shine into your eyes.
- Do not place the projector on an unstable cart, stand, or table.
- Do not operate the projector on its side, or while tilted to one side. Do not tilt the projector more than 30° forward or back.
- If the projector is mounted on a ceiling or wall, it should be installed by qualified technicians using mounting hardware designed for use with this projector.
- When installing or adjusting a ceiling or wall mount, do not use adhesives to prevent the screws from loosening and do not use oils or lubricants. This may cause the projector case to crack and the projector to fall from its ceiling mount. This could cause serious injury to anyone under the mount and could damage the projector.
- Do not use the projector near water, sources of heat, high-voltage electrical wires, or sources of magnetic fields.
- Use the type of power source indicated on the projector. Use of a different power source may result in fire or electric shock. If you are not sure of the power available, consult your dealer or power company.
- Place the projector near a wall outlet where the plug can be easily unplugged.
- Take the following precautions when handling the plug: Do not hold the plug with wet hands. Do not insert the plug into a dusty outlet. Insert the plug firmly into the outlet. Do not pull the power cord when disconnecting the plug; always be sure to hold the plug when disconnecting it. Do not overload wall outlets, extension cords, or power strips. Failure to comply with these precautions could result in fire or electric shock.
- Do not place the projector where the cord can be walked on. This may result in fraying or damage to the plug.
- Unplug the projector from the wall outlet and allow to cool before cleaning. Use a dry cloth (or, for stubborn dirt or stains, a moist cloth that has been wrung dry) for cleaning. Do not use liquid or aerosol cleaners, any sprays containing flammable gas, or solvents such as alcohol, paint thinner, or benzene.
- Do not block the slots and openings in the projector case. They provide ventilation and prevent the projector from overheating. Do not operate the projector on a sofa, rug, or other soft surface, or set it on top of loose papers. Do not cover the projector with a blanket, curtain, or tablecloth. If you are setting up the projector near a wall, leave at least 7.9 inches (20 cm) of space between the wall and the projector.
- Do not operate the projector in a closed-in cabinet unless proper ventilation is provided.

- Never allow objects of any kind to enter any openings in the projector. Do not leave objects, especially flammable objects, near the projector. Never spill liquid of any kind into the projector.
- If you are using two or more projectors side-by-side, leave at least 2 feet (60 cm) of space between the projectors to allow for proper ventilation.
- You may need to clean the air filter and vent. A clogged air filter or vent can block ventilation needed to cool the projector. Do not use canned air, or the gases may leave a residue.
- Do not store the projector outdoors for an extended length of time.
- Except as specifically explained in this manual, do not attempt to service this product yourself. Refer all servicing to qualified personnel. Opening or removing covers may expose you to dangerous voltages and other hazards.
- Never open any covers on the projector except as specifically explained in this manual. Never attempt to disassemble or modify the projector. Refer all repairs to qualified service personnel.
- Unplug the projector from the wall outlet and refer servicing to qualified service personnel under the following conditions: if it does not operate normally when you follow the operating instructions, or exhibits a distinct change in performance; if smoke, strange odors, or strange noises come from the projector; if the power cord or plug is damaged or frayed; if liquid or foreign objects get inside the projector, or if it has been exposed to rain or water; if it has been dropped or the housing has been damaged.
- Do not touch the plug during an electrical storm. Otherwise, you may receive an electric shock.
- Unplug the projector when it will not be used for extended periods.
- Do not use the projector where it may be exposed to rain, water, or excessive humidity.
- Do not use or store the projector where it may be exposed to smoke, steam, corrosive gases, excessive dust, vibration, or shock.
- Do not use the projector where flammable or explosive gases may be present.
- Do not use or store the projector or remote control in a hot location, such as near a heater, in direct sunlight, or in a closed vehicle.
- If you use the projector in a country other than where you purchased it, use the correct power cord for that country.
- Do not stand on the projector or place heavy objects on it.
- Do not use the projector outside of the required temperature range below:
41 to 95 °F (5 to 35 °C) at an altitude of 7500 feet (2286 m) or less, or 41 to 86 °F (5 to 30 °C) at a higher altitude

Doing so may cause an unstable display and could lead to projector damage. Do not use or store the projector where it may be exposed to sudden changes in temperature.

- Do not store the projector outside of the required temperature range of 14 to 140 °F (–10 to 60 °C) or in direct sunlight for long periods of time. Doing so may cause damage to the case.
- Do not place anything that can become warped or damaged by heat near the exhaust vents. Do not bring your hands or face close to the vents while projection is in progress. Do not bring your face close to the projector while it is in use.
- Before you move the projector, make sure its power is turned off, the plug is disconnected from the outlet, and all cables are disconnected.
- Never try to remove the lamp immediately after use because it will be extremely hot. Before removing the lamp, turn off the power and wait at least an hour to allow the lamp to cool completely.
- Do not disassemble the lamp or subject it to impacts.
- Do not place the source of an open flame, such as a lit candle, on or near the projector.
- Do not block the lens during projection using a book or any object other than the lens cover. This could damage the projector or cause a fire.
- Do not modify the power cord. Do not place heavy objects on top of the power cord or bend, twist, or pull it excessively. Keep the power cord away from hot electrical appliances.
- If the lamp breaks, ventilate the room to prevent gases contained in the lamp from being inhaled or coming in contact with your eyes or mouth. If you do inhale gases or gases come in contact with your eyes or mouth, seek medical advice immediately.
- If the projector is mounted overhead and the lamp breaks, be careful to prevent pieces of glass from falling into your eyes or mouth when you open the lamp cover. If pieces of glass do get into your eyes or mouth, seek medical advice immediately.
- Always lower the volume before turning off the projector. Turning on the projector with the volume too high can damage your ears.

Note:  The lamp(s) in this product contain mercury. Please consult your state and local regulations regarding disposal or recycling. Do not put in the trash.

[Restriction of Use](#)

Parent topic: [Notices](#)

Restriction of Use





When this product is used for applications requiring high reliability/safety such as transportation devices related to aviation, rail, marine, automotive; disaster prevention devices; various safety devices; or functional/precision devices, you should use this product only after giving consideration to including fail-safes and redundancies into your design to maintain safety and total system reliability.







Because this product was not intended for use in applications requiring extremely high reliability/safety such as aerospace equipment, main communication equipment, nuclear power control equipment, or medical equipment related to direct medical care, please make your own judgment on this product's suitability after a full evaluation.







Parent topic: [Important Safety Instructions](#)



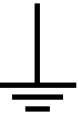

List of Safety Symbols (corresponding to IEC60950-1 A2)

The following table lists the meaning of the safety symbols labeled on the equipment.

No.	Symbol	Approved Standards	Description
1		IEC60417 No.5007	"ON" (power) To indicate connection to the mains.
2		IEC60417 No.5008	"OFF" (power) To indicate disconnection from the mains.
3		IEC60417 No.5009	Stand-by To identify the switch or switch position by means of which part of the equipment is switched on in order to bring it into the stand-by condition.
4		ISO7000 No.0434B, IEC3864-B3.1	Caution To identify general caution when using the product.

No.	Symbol	Approved Standards	Description
5		IEC60417 No.5041	Caution, hot surface To indicate that the marked item can be hot and should not be touched without taking care.
6		IEC60417 No.6042 ISO3864-B3.6	Caution, risk of electric shock To identify equipment that has risk of electric shock.
7		IEC60417 No.5957	For indoor use only To identify electrical equipment designed primarily for indoor use.
8		IEC60417 No.5926	Polarity of DC power connector To identify the positive and negative connections (the polarity) on a piece of equipment to which a DC power supply may be connected.
9		—	Polarity of DC power connector To identify the positive and negative connections (the polarity) on a piece of equipment to which a DC. power supply may be connected.
10		IEC60417 No.5001B	Battery, general On battery powered equipment. To identify a device for instance a cover for the battery compartment, or the connector terminals.
11		IEC60417 No.5002	Positioning of cell To identify the battery holder itself and to identify the positioning of the cell(s) inside the battery holder.

No.	Symbol	Approved Standards	Description
12		—	<p>Positioning of cell</p> <p>To identify the battery holder itself and to identify the positioning of the cell(s) inside the battery holder.</p>
13		IEC60417 No.5019	<p>Protective earth</p> <p>To identify any terminal which is intended for connection to an external conductor for protection against electric shock in case of a fault, or the terminal of a protective earth electrode.</p>
14		IEC60417 No.5017	<p>Earth</p> <p>To identify an earth (ground) terminal in cases where neither the symbol No.13 is explicitly required.</p>
15		IEC60417 No.5032	<p>Alternating current</p> <p>To indicate on the rating plate that the equipment is suitable for alternating current only; to identify relevant terminals.</p>
16		IEC60417 No.5031	<p>Direct current</p> <p>To indicate on the rating plate that the equipment is suitable for direct current only; to identify relevant terminals.</p>
17		IEC60417 No.5172	<p>Class II equipment</p> <p>To identify equipment meeting the safety requirements specified for Class II equipment according to IEC 61140.</p>
18		ISO 3864	<p>General prohibition</p> <p>To identify actions or operations that are prohibited.</p>

No.	Symbol	Approved Standards	Description
19		ISO 3864	Contact prohibition To indicate injury that could occur due to touching a specific part of the equipment.
20		—	Never look into the optical lens while the projector is on.
21		—	To indicate that the marked item don't place anything on projector.
22		ISO3864 IEC60825-1	Caution, laser radiation To indicate the equipment has a laser radiation part.
23		ISO 3864	Disassembly prohibition To indicate a risk of injury, such as electric shock, if the equipment is disassembled.

Parent topic: [Notices](#)

FCC Compliance Statement

For United States Users

This equipment has been tested and found to comply with the limits for a Class B digital device, pursuant to Part 15 of the FCC Rules. These limits are designed to provide reasonable protection against harmful interference in a residential installation. This equipment generates, uses, and can radiate radio frequency energy and, if not installed and used in accordance with the instructions, may cause harmful interference to radio communications. However, there is no guarantee that interference will not occur in a particular installation. If this equipment does cause interference to radio and television reception, which can be determined by turning the equipment off and on, the user is encouraged to try to correct the interference by one or more of the following measures:

- Reorient or relocate the receiving antenna.
- Increase the separation between the equipment and receiver.

- Connect the equipment into an outlet on a circuit different from that to which the receiver is connected.
- Consult the dealer or an experienced radio/TV technician for help.

WARNING

The connection of a non-shielded equipment interface cable to this equipment will invalidate the FCC Certification or Declaration of this device and may cause interference levels which exceed the limits established by the FCC for this equipment. It is the responsibility of the user to obtain and use a shielded equipment interface cable with this device. If this equipment has more than one interface connector, do not leave cables connected to unused interfaces. Changes or modifications not expressly approved by the manufacturer could void the user's authority to operate the equipment.

For Canadian Users

CAN ICES-3(B)/NMB-3(B)

Parent topic: [Notices](#)

Binding Arbitration and Class Waiver

1. DISPUTES, BINDING INDIVIDUAL ARBITRATION, AND WAIVER OF CLASS ACTIONS AND CLASS ARBITRATIONS

1.1 Disputes. The terms of this Section 1 shall apply to all Disputes between you and Epson. The term "Dispute" is meant to have the broadest meaning permissible under law and includes any dispute, claim, controversy or action between you and Epson arising out of or relating to this Agreement, Epson branded products (hardware and including any related software), or other transaction involving you and Epson, whether in contract, warranty, misrepresentation, fraud, tort, intentional tort, statute, regulation, ordinance, or any other legal or equitable basis. "DISPUTE" DOES NOT INCLUDE IP CLAIMS, or more specifically, a claim or cause of action for (a) trademark infringement or dilution, (b) patent infringement, (c) copyright infringement or misuse, or (d) trade secret misappropriation (an "IP Claim"). You and Epson also agree, notwithstanding Section 1.6, that a court, not an arbitrator, may decide if a claim or cause of action is for an IP Claim.

1.2 Binding Arbitration. You and Epson agree that all Disputes shall be resolved by binding arbitration according to this Agreement. **ARBITRATION MEANS THAT YOU WAIVE YOUR RIGHT TO A JUDGE OR JURY IN A COURT PROCEEDING AND YOUR GROUNDS FOR APPEAL ARE LIMITED.**

Pursuant to this Agreement, binding arbitration shall be administered by JAMS, a nationally recognized arbitration authority, pursuant to its code of procedures then in effect for consumer related disputes, but excluding any rules that permit joinder or class actions in arbitration (for more detail on procedure, see Section 1.6 below). You and Epson understand and agree that (a) the Federal Arbitration Act (9 U.S.C. §1, et seq.) governs the interpretation and enforcement of this Section 1, (b) this Agreement

memorializes a transaction in interstate commerce, and (c) this Section 1 shall survive termination of this Agreement.

1.3 Pre-Arbitration Steps and Notice. Before submitting a claim for arbitration, you and Epson agree to try, for sixty (60) days, to resolve any Dispute informally. If Epson and you do not reach an agreement to resolve the Dispute within the sixty (60) days, you or Epson may commence an arbitration. Notice to Epson must be addressed to: Epson America, Inc., ATTN: Legal Department, 3840 Kilroy Airport Way, Long Beach, CA 90806 (the "Epson Address"). The Dispute Notice to you will be sent to the most recent address Epson has in its records for you. For this reason, it is important to notify us if your address changes by emailing us at EAILEgal@ea.epson.com or writing us at the Epson Address above. Notice of the Dispute shall include the sender's name, address and contact information, the facts giving rise to the Dispute, and the relief requested (the "Dispute Notice"). Following receipt of the Dispute Notice, Epson and you agree to act in good faith to resolve the Dispute before commencing arbitration.

1.4 Small Claims Court. Notwithstanding the foregoing, you may bring an individual action in the small claims court of your state or municipality if the action is within that court's jurisdiction and is pending only in that court.

1.5 WAIVER OF CLASS ACTIONS AND CLASS ARBITRATIONS. YOU AND EPSON AGREE THAT EACH PARTY MAY BRING DISPUTES AGAINST THE OTHER PARTY ONLY IN AN INDIVIDUAL CAPACITY, AND NOT AS A PLAINTIFF OR CLASS MEMBER IN ANY CLASS OR REPRESENTATIVE PROCEEDING, INCLUDING WITHOUT LIMITATION FEDERAL OR STATE CLASS ACTIONS, OR CLASS ARBITRATIONS. CLASS ACTION LAWSUITS, CLASS-WIDE ARBITRATIONS, PRIVATE ATTORNEY-GENERAL ACTIONS, AND ANY OTHER PROCEEDING WHERE SOMEONE ACTS IN A REPRESENTATIVE CAPACITY ARE NOT ALLOWED. ACCORDINGLY, UNDER THE ARBITRATION PROCEDURES OUTLINED IN THIS SECTION, AN ARBITRATOR SHALL NOT COMBINE OR CONSOLIDATE MORE THAN ONE PARTY'S CLAIMS WITHOUT THE WRITTEN CONSENT OF ALL AFFECTED PARTIES TO AN ARBITRATION PROCEEDING.

1.6 Arbitration Procedure. If you or Epson commences arbitration, the arbitration shall be governed by the rules of JAMS that are in effect when the arbitration is filed, excluding any rules that permit arbitration on a class or representative basis (the "JAMS Rules"), available at <http://www.jamsadr.com> or by calling 1-800-352-5267, and under the rules set forth in this Agreement. All Disputes shall be resolved by a single neutral arbitrator, and both parties shall have a reasonable opportunity to participate in the selection of the arbitrator. The arbitrator is bound by the terms of this Agreement. The arbitrator, and not any federal, state or local court or agency, shall have exclusive authority to resolve all disputes arising out of or relating to the interpretation, applicability, enforceability or formation of this Agreement, including any claim that all or any part of this Agreement is void or voidable. Notwithstanding this broad delegation of authority to the arbitrator, a court may determine the limited question of whether a claim or cause of action is for an IP Claim, which is excluded from the definition of "Disputes" in Section 1.1 above. The arbitrator shall be empowered to grant whatever relief would be available in a court under law or in equity. The arbitrator may award you the same damages as a court could, and may award

declaratory or injunctive relief only in favor of the individual party seeking relief and only to the extent necessary to provide relief warranted by that party's individual claim. In some instances, the costs of arbitration can exceed the costs of litigation and the right to discovery may be more limited in arbitration than in court. The arbitrator's award is binding and may be entered as a judgment in any court of competent jurisdiction.

You may choose to engage in arbitration hearings by telephone. Arbitration hearings not conducted by telephone shall take place in a location reasonably accessible from your primary residence, or in Orange County, California, at your option.

a) Initiation of Arbitration Proceeding. If either you or Epson decides to arbitrate a Dispute, both parties agree to the following procedure:

(i) Write a Demand for Arbitration. The demand must include a description of the Dispute and the amount of damages sought to be recovered. You can find a copy of a Demand for Arbitration at <http://www.jamsadr.com> ("Demand for Arbitration").

(ii) Send three copies of the Demand for Arbitration, plus the appropriate filing fee, to: JAMS, 500 North State College Blvd., Suite 600 Orange, CA 92868, U.S.A.

(iii) Send one copy of the Demand for Arbitration to the other party (same address as the Dispute Notice), or as otherwise agreed by the parties.

b) Hearing Format. During the arbitration, the amount of any settlement offer made shall not be disclosed to the arbitrator until after the arbitrator determines the amount, if any, to which you or Epson is entitled. The discovery or exchange of non-privileged information relevant to the Dispute may be allowed during the arbitration.

c) Arbitration Fees. Epson shall pay, or (if applicable) reimburse you for, all JAMS filings and arbitrator fees for any arbitration commenced (by you or Epson) pursuant to provisions of this Agreement.

d) Award in Your Favor. For Disputes in which you or Epson seeks \$75,000 or less in damages exclusive of attorney's fees and costs, if the arbitrator's decision results in an award to you in an amount greater than Epson's last written offer, if any, to settle the Dispute, Epson will: (i) pay you \$1,000 or the amount of the award, whichever is greater; (ii) pay you twice the amount of your reasonable attorney's fees, if any; and (iii) reimburse you for any expenses (including expert witness fees and costs) that your attorney reasonably accrues for investigating, preparing, and pursuing the Dispute in arbitration. Except as agreed upon by you and Epson in writing, the arbitrator shall determine the amount of fees, costs, and expenses to be paid by Epson pursuant to this Section 1.6d).

e) Attorney's Fees. Epson will not seek its attorney's fees and expenses for any arbitration commenced involving a Dispute under this Agreement. Your right to attorney's fees and expenses under Section 1.6d) above does not limit your rights to attorney's fees and expenses under applicable law; notwithstanding the foregoing, the arbitrator may not award duplicative awards of attorney's fees and expenses.

1.7 Opt-out. You may elect to opt-out (exclude yourself) from the final, binding, individual arbitration procedure and waiver of class and representative proceedings specified in this Agreement by sending a written letter to the Epson Address within thirty (30) days of your assent to this Agreement (including without limitation the purchase, download, installation of the Software or other applicable use of Epson Hardware, products and services) that specifies (i) your name, (ii) your mailing address, and (iii) your request to be excluded from the final, binding individual arbitration procedure and waiver of class and representative proceedings specified in this Section 1. In the event that you opt-out consistent with the procedure set forth above, all other terms shall continue to apply, including the requirement to provide notice prior to litigation.

1.8 Amendments to Section 1. Notwithstanding any provision in this Agreement to the contrary, you and Epson agree that if Epson makes any future amendments to the dispute resolution procedure and class action waiver provisions (other than a change to Epson's address) in this Agreement, Epson will obtain your affirmative assent to the applicable amendment. If you do not affirmatively assent to the applicable amendment, you are agreeing that you will arbitrate any Dispute between the parties in accordance with the language of this Section 1 (or resolve disputes as provided for in Section 1.7, if you timely elected to opt-out when you first assented to this Agreement).

1.9 Severability. If any provision in this Section 1 is found to be unenforceable, that provision shall be severed with the remainder of this Agreement remaining in full force and effect. **The foregoing shall not apply to the prohibition against class or representative actions as provided in Section 1.5. This means that if Section 1.5 is found to be unenforceable, the entire Section 1 (but only Section 1) shall be null and void.**

Parent topic: [Notices](#)

Trademarks

EPSON®, Instant Off®, PowerLite®, and Quick Corner® are registered trademarks, and EPSON Exceed Your Vision is a registered logomark of Seiko Epson Corporation.

Accolade® and PrivateLine® are registered trademarks; Duet™ and SizeWise™ are trademarks; and Epson StoreSM and Extra CareSM are service marks of Epson America, Inc.

Mac, macOS, and OS X are trademarks of Apple Inc., registered in the U.S. and other countries.

Android™ is a trademark of Google Inc.

HDMI and High-Definition Multimedia Interface are the trademarks or registered trademarks of HDMI

Licensing LLC.  HIGH DEFINITION MULTIMEDIA INTERFACE

General Notice: Other product names used herein are for identification purposes only and may be trademarks of their respective owners. Epson disclaims any and all rights in those marks.



Parent topic: [Notices](#)

Copyright Notice

All rights reserved. No part of this publication may be reproduced, stored in a retrieval system, or transmitted in any form or by any means, electronic, mechanical, photocopying, recording, or otherwise, without the prior written permission of Seiko Epson Corporation. The information contained herein is designed only for use with this Epson product. Epson is not responsible for any use of this information as applied to other products.

Neither Seiko Epson Corporation nor its affiliates shall be liable to the purchaser of this product or third parties for damages, losses, costs, or expenses incurred by purchaser or third parties as a result of: accident, misuse, or abuse of this product or unauthorized modifications, repairs, or alterations to this product, or (excluding the U.S.) failure to strictly comply with Seiko Epson Corporation's operating and maintenance instructions.

Seiko Epson Corporation shall not be liable for any damages or problems arising from the use of any options or any consumable products other than those designated as Original Epson Products or Epson Approved Products by Seiko Epson Corporation.

This information is subject to change without notice.

[A Note Concerning Responsible Use of Copyrighted Materials](#)

[Copyright Attribution](#)

Parent topic: [Notices](#)

A Note Concerning Responsible Use of Copyrighted Materials

Epson encourages each user to be responsible and respectful of the copyright laws when using any Epson product. While some countries' laws permit limited copying or reuse of copyrighted material in certain circumstances, those circumstances may not be as broad as some people assume. Contact your legal advisor for any questions regarding copyright law.

Parent topic: [Copyright Notice](#)

Copyright Attribution

© 2017 Epson America, Inc.

11/17

CPD-54229

Parent topic: [Copyright Notice](#)