



# EF12 User's Guide



---

# Contents

<b>EF12 User's Guide</b> .....	<b>7</b>
<b>Introduction to Your Projector</b> .....	<b>8</b>
Projector Features .....	8
Product Box Contents .....	9
Additional Components .....	9
Optional Equipment and Replacement Parts .....	10
Warranty and Registration Information (U.S. and Canada) .....	11
Warranty and Registration Information (Latin America) .....	11
Notations Used in the Documentation .....	12
Where to Go for Additional Information .....	12
Projector Part Locations .....	12
Projector Parts - Front/Top .....	13
Projector Parts - Rear .....	14
Projector Parts - Base .....	15
Projector Parts - Control Panel .....	16
Projector Parts - Remote Control .....	17
<b>Setting Up the Projector</b> .....	<b>19</b>
Projector Placement .....	19
Projector Setup and Installation Options .....	19
Projection Distance .....	21
Installing the Projector in a Mount or Tripod .....	25
Projector Connections .....	29
Connecting to an HDMI Video Source .....	30
Connecting Headphones .....	30
Connecting External Speakers Using HDMI ARC .....	31
Installing Batteries in the Remote Control .....	32
Setting Up Android TV .....	34
<b>Using Basic Projector Features</b> .....	<b>36</b>
Turning On the Projector .....	36
Using the Home Screen .....	38

Turning Off the Projector .....	38
Projection Modes .....	39
Changing the Projection Mode Using the Menus .....	39
Adjusting the Image Height .....	40
Image Shape .....	41
Correcting Image Shape with H/V Keystone .....	41
Correcting Image Shape with Corner Adjustment .....	43
Remote Control Operation .....	44
Using Voice Commands to Control Your Projector .....	45
Pairing the Remote Control .....	45
Selecting an Image Source .....	46
Using Your Projector as a Chromecast .....	46
Image Aspect Ratio .....	46
Changing the Image Aspect Ratio .....	47
Available Image Aspect Ratios .....	48
Color Mode .....	48
Changing the Color Mode .....	49
Available Color Modes .....	50
Turning On Automatic Luminance Adjustment .....	50
Adjusting Picture Quality in Detail .....	51
Controlling the Volume with the Volume Buttons .....	53
Changing the Sound Mode .....	53
Available Sound Modes .....	54
<b>Adjusting Projector Features .....</b>	<b>56</b>
Using the Projector as a Bluetooth Speaker .....	56
Operating Connected Devices Using the HDMI Link Features .....	57
Shutting Off the Picture Temporarily .....	58
Updating the Firmware .....	58
Resetting the Projector .....	59
<b>Adjusting the Menu Settings .....</b>	<b>60</b>
Using the Projector's Menus .....	60
Image Quality Settings - Picture Menu .....	61
Sound Quality Settings - Sound Menu .....	63

Projector Feature Settings - Display Menu .....	66
Projector Feature Settings - Settings Menu .....	67
<b>Maintaining and Transporting the Projector .....</b>	<b>70</b>
Projector Maintenance .....	70
Cleaning the Lens .....	71
Cleaning the Projector Case .....	71
Air Filter and Vent Maintenance .....	71
Cleaning the Air Filter and Vents .....	72
Replacing the Air Filter .....	73
Replacing the Remote Control Batteries .....	77
Transporting the Projector .....	79
<b>Solving Problems .....</b>	<b>80</b>
Projection Problem Tips .....	80
Projector Light Status .....	81
Solving Image or Sound Problems .....	83
Solutions When No Image Appears .....	83
Solutions When "No Signal" Message Appears .....	84
Displaying From a PC Laptop .....	85
Displaying From a Mac Laptop .....	85
Solutions When the Image is Not Rectangular .....	85
Solutions When Only a Partial Image Appears .....	86
Solutions When the Image Contains Noise or Static .....	86
Solutions When the Image is Fuzzy or Blurry .....	87
Solutions When the Image Brightness or Colors are Incorrect .....	88
Solutions to Sound Problems .....	88
Solutions to Bluetooth Audio Problems .....	89
Solving Projector or Remote Control Operation Problems .....	90
Solutions to Projector Power or Shut-Off Problems .....	91
Solutions to Remote Control Problems .....	91
Solutions to HDMI Link Problems .....	92
Solving Network Problems .....	93
Solutions When Wireless Authentication Fails .....	93
Where to Get Help (U.S. and Canada) .....	93

Where to Get Help (Latin America).....	94
<b>Technical Specifications .....</b>	<b>97</b>
General Projector Specifications .....	97
Projector Light Source Specifications.....	98
Remote Control Specifications .....	99
Projector Dimension Specifications.....	99
Projector Electrical Specifications .....	99
Projector Environmental Specifications.....	100
Bluetooth Specifications .....	100
Projector Safety and Approvals Specifications.....	101
Supported Video Display Formats.....	101
<b>Notices .....</b>	<b>103</b>
Recycling (U.S. and Canada).....	103
Important Safety Information .....	103
Laser Safety Information .....	104
Important Safety Instructions.....	106
Restriction of Use .....	110
List of Safety Symbols .....	111
FCC Compliance Statement.....	115
Binding Arbitration and Class Waiver .....	116
Trademarks .....	119
Copyright Notice.....	119
A Note Concerning Responsible Use of Copyrighted Materials.....	120
Copyright Attribution .....	120

---

## EF12 User's Guide

Welcome to the EF12 *User's Guide*.

For a printable PDF copy of this guide, [click here](#).

---

# Introduction to Your Projector

Refer to these sections to learn more about your projector and this manual.

[Projector Features](#)

[Notations Used in the Documentation](#)

[Where to Go for Additional Information](#)

[Projector Part Locations](#)

## Projector Features

The EF12 projector includes these special features:

### **Bright, high-resolution projection system**

- Up to 1000 lumens of color brightness (color light output) and white brightness (white light output)

**Note:** Color brightness (color light output) and white brightness (white light output) will vary depending on usage conditions. Color light output measured in accordance with IDMS 15.4; white light output measured in accordance with ISO 21118.

- High-definition mini cinema lens
- Advanced 3LCD technology
- Epson microlaser array projection technology
- Up to 150 inches (12.5 ft diagonal) projected image size (no screen required)

### **Flexible connectivity**

- Built-in Android TV
- Built-in Chromecast functionality
- Two HDMI ports for streaming devices or other HDMI sources
- Small, portable design
- Audio out port for connecting headphones
- Powerful 5W, 2-channel Yamaha stereo speaker system

### **Innovative display and operation features**

- Long-life laser light source



- 200,000:1 contrast ratio and Dynamic Contrast control for sharp, detailed images
- Use the projector as a Bluetooth speaker
- One remote controls projector and connected HDMI CEC devices

[Product Box Contents](#)

[Additional Components](#)

[Optional Equipment and Replacement Parts](#)

[Warranty and Registration Information \(U.S. and Canada\)](#)

[Warranty and Registration Information \(Latin America\)](#)

**Parent topic:** [Introduction to Your Projector](#)

## Product Box Contents

Save all the packaging in case you need to ship the projector. Always use the original packaging (or equivalent) when shipping.

Make sure your projector box included all of these parts:

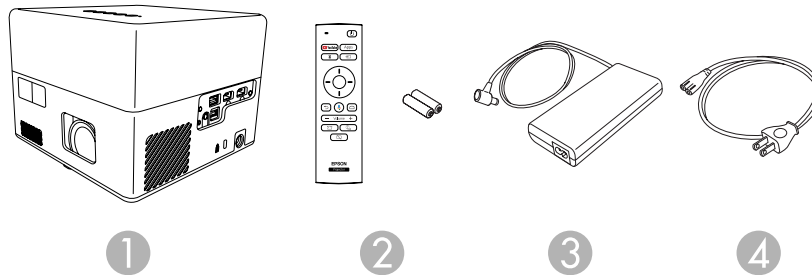

- 1 Projector
- 2 Projector remote control and 2 AAA batteries
- 3 AC adapter
- 4 Power cord

**Parent topic:** [Projector Features](#)

## Additional Components

Depending on how you plan to use the projector, you may need to obtain additional components.

**Note:** To connect a Mac that does not include a compatible HDMI output port, you need to obtain an adapter that allows you to connect to the HDMI port on the projector. Contact Apple for compatible HDMI adapter options. To connect a smartphone or tablet, you may need to obtain an adapter that allows you to connect to the projector. This allows you to mirror your smartphone or tablet screens, watch movies, and more. Contact your device manufacturer for compatible adapter options.

**Note:** The projector's HDMI port does not support MHL.

Unless listed as available from Epson in this table, see your local computer or electronics dealer for purchase information.

Signal or connection type	Additional component necessary
HDMI	Compatible HDMI cable <b>U.S. and Canada:</b> Available for purchase from Epson or an authorized Epson reseller. <b>Latin America:</b> Available for purchase from an authorized Epson reseller. <b>Note:</b> Older Mac computers (2009 and earlier) may not support HDMI audio.
USB	Compatible USB cable
Audio out	Commercially available 3.5 mm mini jack stereo cable

Parent topic: [Projector Features](#)

## Optional Equipment and Replacement Parts

**U.S. and Canada:** You can purchase screens, other optional accessories, and replacement parts from an Epson authorized reseller. To find the nearest reseller, call 800-GO-EPSON (800-463-7766) in the U.S. or 800-807-7766 in Canada. Or you can purchase online at [epsonstore.com](http://epsonstore.com) (U.S. sales) or [epsonstore.ca](http://epsonstore.ca) (Canadian sales).

**Latin America:** You can purchase screens, other optional accessories, and replacement parts from an Epson authorized reseller. To find the nearest reseller, go to [latin.epson.com](http://latin.epson.com). Or you can click the "Where to Get Help" link below to contact your nearest sales office.

**Note:** Availability of accessories varies by country.

Epson offers the following optional accessories and replacement parts for your projector:

**U.S. and Canada:**

Option or part	Part number
Mounting plate (ELPMB65)	V12HA40AA0
Safety wire set (ELPWR01)	V12H003W01
Air filter set (ELPAF61)	V13H134AA0

In addition to the accessories listed above, a 1-year extended service plan is available.

**Latin America:**

Option or part	Part number
Mounting plate (ELPMB65)	V12HA40AA0
Safety wire set (ELPWR01)	V12H003W01
Air filter set (ELPAF61)	V13H134AA0

**Parent topic:** [Projector Features](#)

**Related references**

[Where to Get Help \(U.S. and Canada\)](#)

[Where to Get Help \(Latin America\)](#)

## Warranty and Registration Information (U.S. and Canada)

Your projector comes with a basic warranty that lets you project with confidence. For details, see the warranty brochure that came with your projector.

Register your product online at this site: [epson.com/webreg](http://epson.com/webreg)

Registering also lets you receive special updates on new accessories, products, and services.

**Parent topic:** [Projector Features](#)

## Warranty and Registration Information (Latin America)

Your projector comes with a basic warranty that lets you project with confidence. For details, see the warranty that came with your projector.

Register your product online at [latin.epson.com/support](http://latin.epson.com/support), search for your product, and select **Register**.

Registering also lets you receive special updates on new accessories, products, and services.

**Parent topic:** [Projector Features](#)

## Notations Used in the Documentation

Follow the guidelines in these notations as you read your documentation:

- **Warnings** must be followed carefully to avoid bodily injury.
- **Cautions** must be observed to avoid damage to your equipment.
- **Notes** contain important information about your projector.
- **Tips** contain additional projection information.

**Parent topic:** [Introduction to Your Projector](#)

## Where to Go for Additional Information

Need quick help on using your projector? Here's where to look for help:

- <https://support.google.com/androidtv/> for Android TV support
- [epson.com/support](https://www.epson.com/support) (U.S.), [epson.ca/support](https://www.epson.ca/support) (Canada), or [latin.epson.com/support](https://www.latin.epson.com/support) (Caribbean)

View FAQs (frequently asked questions) and e-mail your questions to Epson technical support 24 hours a day.

- If you still need help after checking this manual and any other sources listed here, you can use the Epson PrivateLine Support service to get help fast (U.S. and Canada only). For details, see "Where to Get Help."

**Parent topic:** [Introduction to Your Projector](#)

## Projector Part Locations

Check the projector part illustrations to learn about the parts on your projector.

[Projector Parts - Front/Top](#)

[Projector Parts - Rear](#)

[Projector Parts - Base](#)

[Projector Parts - Control Panel](#)

[Projector Parts - Remote Control](#)

**Parent topic:** [Introduction to Your Projector](#)

## Projector Parts - Front/Top

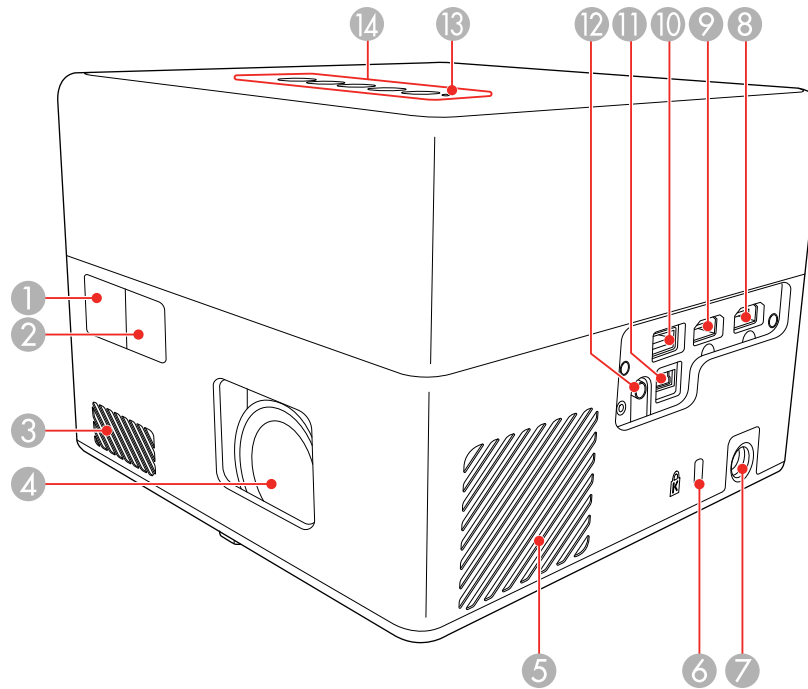

- 1 Remote receiver
- 2 Camera (for adjusting images)
- 3 Air intake vent
- 4 Lens
- 5 Air intake vent (air filter)
- 6 Kensington security slot
- 7 AC adapter port
- 8 **HDM11** port
- 9 **HDM12 (ARC)** port
- 10 **USB-A** port

- 11 Service port
- 12 Audio out port
- 13 Status indicator
- 14 Control panel

Parent topic: [Projector Part Locations](#)

## Projector Parts - Rear

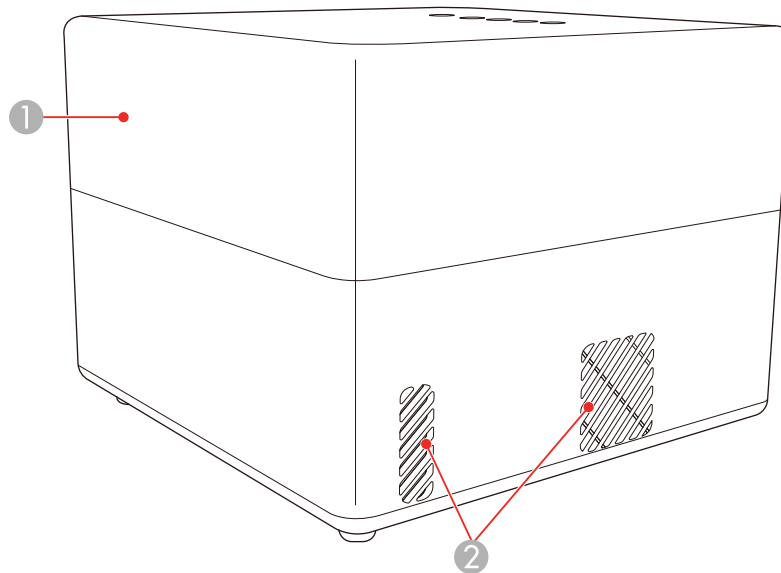

- 1 Speaker
- 2 Air exhaust vents

**Warning:** While projecting, do not put your face or hands near the air exhaust vents, and do not place objects that may become warped or damaged by heat near the vents. Hot air from the air exhaust vents could cause burns or other injuries, or warping of projector parts.

Parent topic: [Projector Part Locations](#)

## Projector Parts - Base

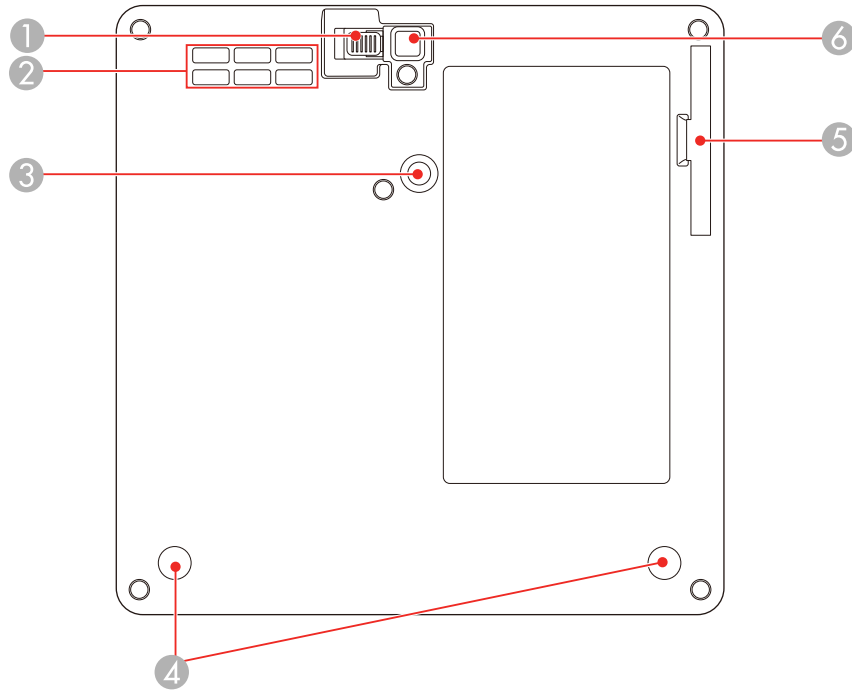

- 1 Foot release lever
- 2 Air intake vent
- 3 Mount plate attachment point (M4 × 6 mm screws)
- 4 Rear feet (removable for mounting)
- 5 Air filter cover
- 6 Front adjustable foot

Parent topic: [Projector Part Locations](#)

## Projector Parts - Control Panel

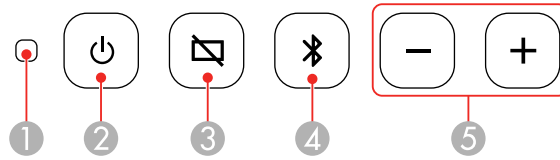



- 1 Status indicator
- 2  power button
- 3 Blank button
- 4 Bluetooth Speaker mode button
- 5 Volume buttons





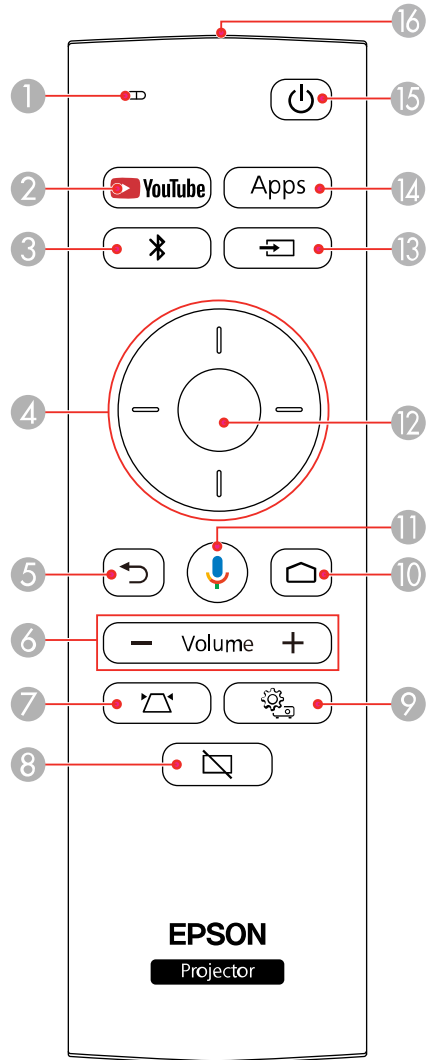



**Parent topic:** [Projector Part Locations](#)



## Projector Parts - Remote Control



- 1 Microphone (listens for voice commands after pressing the  mic button)
- 2 **YouTube** button (opens the YouTube app)

- 3  Bluetooth Speaker mode button (switches to Bluetooth Speaker mode)
- 4 Arrow buttons (move through on-screen options)
- 5  Esc button (cancels/exits function)
- 6 Volume up and volume down buttons
- 7  Corner Adjustment button (displays the Corner Adjustment screen to adjust the image shape)
- 8  Blank button (turns off picture)
- 9  Settings button (accesses projector menus)
- 10  Home button (accesses Android TV Home screen)
- 11  mic button (operates Android TV using voice commands)
- 12 **Enter** button (selects options)
- 13  Source Search button (changes the input source)
- 14 **Apps** button (displays available Android TV apps)
- 15  Power button
- 16 Remote control emitter

**Parent topic:** [Projector Part Locations](#)

---

# Setting Up the Projector

Follow the instructions in these sections to set up your projector for use.

[Projector Placement](#)

[Projector Connections](#)

[Installing Batteries in the Remote Control](#)

[Setting Up Android TV](#)

## Projector Placement

You can place the projector on almost any flat surface to project an image.

You can also install the projector in a ceiling mount if you want to use it in a fixed location. A mounting plate is required when installing the projector on a VESA-compliant mount.

There is no vertical or horizontal limit to how the projector can be installed.

Keep these considerations in mind as you select a projector location:

- Place the projector on a sturdy, level surface or install it using a compatible mount.
- Place the projector parallel to the screen.
- Leave plenty of space around and under the projector for ventilation, and do not place it on top of or next to anything that could block the vents.
- Position the projector within reach of a grounded electrical outlet or extension cord.

Make sure you read the safety instructions when placing or mounting your projector. See the link below.

[Projector Setup and Installation Options](#)

[Projection Distance](#)

[Installing the Projector in a Mount or Tripod](#)

**Parent topic:** [Setting Up the Projector](#)

**Related references**

[Important Safety Instructions](#)

## Projector Setup and Installation Options

You can set up or install your projector in the following ways:

Front

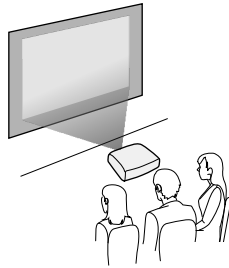

Front ceiling

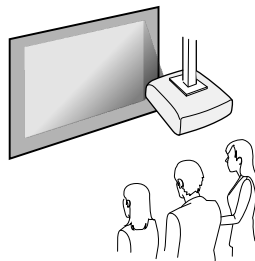

Toward the ceiling

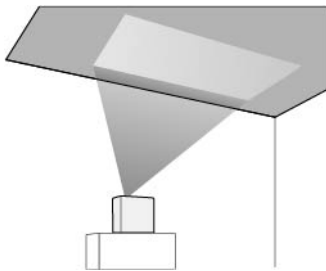

**Note:** We recommend installing the projector on a protective mat to prevent the projector or the cloth covering the speaker from being damaged, or the color from staining unprotected surfaces. The sound from the projector's speaker may be muffled.

**Note:** Be sure to leave the following amount of space around the projector to avoid blocking the air exhaust and intake vents.

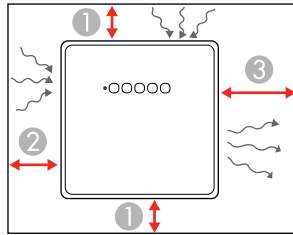

- 1 3.94 inches (10 cm)
- 2 7.87 inches (20 cm)
- 3 11.81 inches (30 cm)

**Caution:** Install the AC adapter more than 11.8 inches (30 cm) away from the projector. If the temperature of the AC adapter rises due to heat from the projector, the projector may not operate properly.

If you project from the ceiling, be sure to select the correct **Projection** setting in the Display menu.

**Parent topic:** [Projector Placement](#)

**Related references**

[Projector Feature Settings - Display Menu](#)

## Projection Distance

The distance at which you place the projector from the screen determines the approximate size of the image. The image size increases the farther the projector is from the screen, but can vary depending on the zoom factor, aspect ratio, and other settings.

Use the tables here to determine approximately how far to place the projector from the screen based on the size of the projected image. (Conversion figures may have been rounded up or down.) You can also use the Projection Distance Calculator [here](#) (U.S.), [here](#) (Canada), or [here](#) (Caribbean).

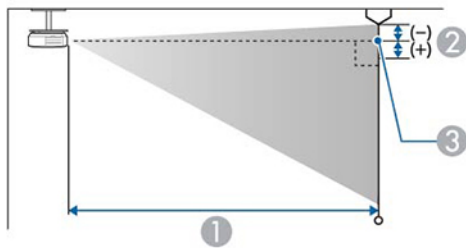
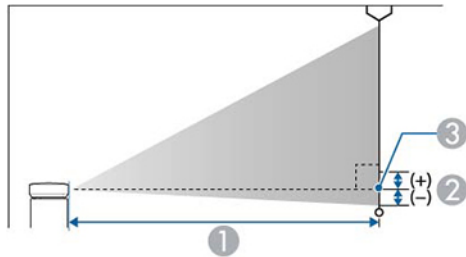

- 1 Projection distance
- 2 Distance from the center of the lens to the base of the screen

<b>16:9 Aspect Ratio Image or Screen</b>		
<b>Screen or image size</b>	<b>Projection distance (1)</b>	<b>Distance from center of lens to base of screen (2)</b>
30 inches	26 inches (65 cm)	0 inches (0 cm)
40 inches	35 inches (88 cm)	0 inches (0 cm)
50 inches	43 inches (110 cm)	0 inches (0 cm)

<b>16:9 Aspect Ratio Image or Screen</b>		
<b>Screen or image size</b>	<b>Projection distance (1)</b>	<b>Distance from center of lens to base of screen (2)</b>
60 inches	52 inches (133 cm)	0 inches (0 cm)
70 inches	61 inches (156 cm)	0 inches (0 cm)
80 inches	70 inches (179 cm)	0 inches (0 cm)
90 inches	79 inches (202 cm)	0 inches (0 cm)
100 inches	88 inches (224 cm)	0 inches (0 cm)
120 inches	106 inches (270 cm)	0 inches (0 cm)
150 inches	133 inches (338 cm)	0 inches (0 cm)

<b>16:10 Aspect Ratio Image or Screen</b>		
<b>Screen or image size</b>	<b>Projection distance (1) Wide to Tele</b>	<b>Distance from center of lens to base of screen (2)</b>
30 inches	28 inches (70 cm)	0 inches (0 cm)
40 inches	37 inches (95 cm)	0 inches (0 cm)
50 inches	47 inches (120 cm)	0 inches (0 cm)

<b>16:10 Aspect Ratio Image or Screen</b>		
<b>Screen or image size</b>	<b>Projection distance (1) Wide to Tele</b>	<b>Distance from center of lens to base of screen (2)</b>
60 inches	57 inches (144 cm)	0 inches (0 cm)
70 inches	66 inches (169 cm)	0 inches (0 cm)
80 inches	76 inches (194 cm)	0 inches (0 cm)
90 inches	86 inches (218 cm)	0 inches (0 cm)
100 inches	96 inches (243 cm)	0 inches (0 cm)
120 inches	115 inches (292 cm)	0 inches (0 cm)
130 inches	125 inches (317 cm)	0 inches (0 cm)
140 inches	134 inches (341 cm)	0 inches (0 cm)

<b>4:3 Aspect Ratio Image or Screen</b>		
<b>Screen or image size</b>	<b>Projection distance (1) Wide to Tele</b>	<b>Distance from center of lens to base of screen (2)</b>
30 inches	32 inches (80 cm)	0 inches (0 cm)
40 inches	43 inches (108 cm)	0 inches (0 cm)



<b>4:3 Aspect Ratio Image or Screen</b>		
<b>Screen or image size</b>	<b>Projection distance (1) Wide to Tele</b>	<b>Distance from center of lens to base of screen (2)</b>
50 inches	54 inches (136 cm)	0 inches (0 cm)
60 inches	64 inches (164 cm)	0 inches (0 cm)
70 inches	75 inches (192 cm)	0 inches (0 cm)
80 inches	86 inches (220 cm)	0 inches (0 cm)
90 inches	97 inches (247 cm)	0 inches (0 cm)
100 inches	108 inches (275 cm)	0 inches (0 cm)
120 inches	130 inches (331 cm)	0 inches (0 cm)

Parent topic: [Projector Placement](#)

## Installing the Projector in a Mount or Tripod

When installing the projector in an optional mount, follow these guidelines:

**Note:** You will require the optional mounting plate (ELPMB65) to install the projector in a mount.

- You can install the projector on VESA-compliant (75 × 75 mm) mounting hardware.
- You can install the projector on a tripod that uses 1/4-20UNC size fixed screws
- When installing the projector in a high place, be sure to install the optional security wire set (ELPWR01) for safety purposes

1. Turn the projector upside down.

2. Remove the rear feet by turning them clockwise.

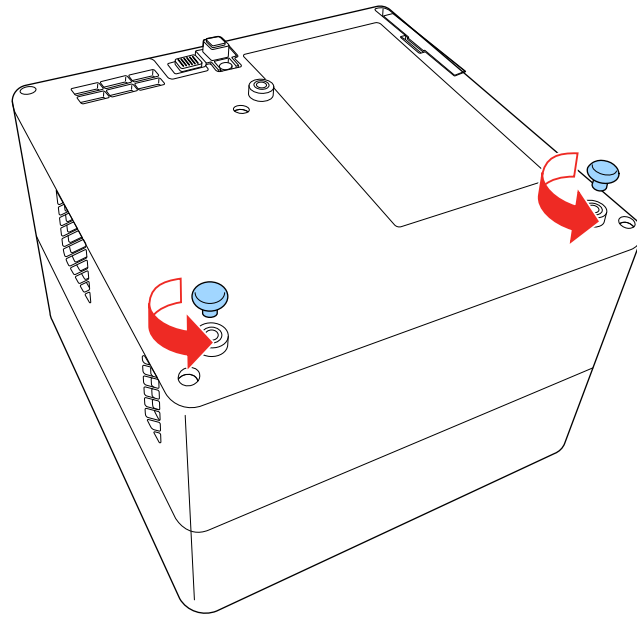

3. When installing the projector in a high place, thread the optional security wire set (ELPWR01) through the mount plate.

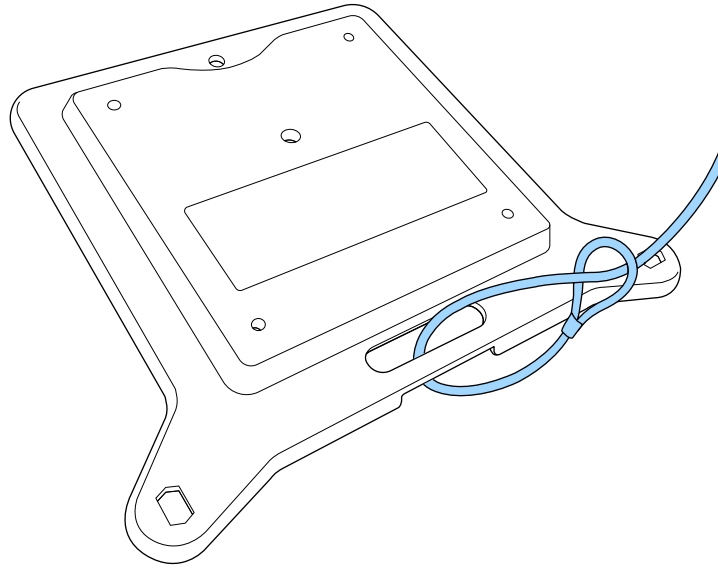

4. Attach the mounting plate to the projector and secure it in place with the screws that came with the mounting plate.

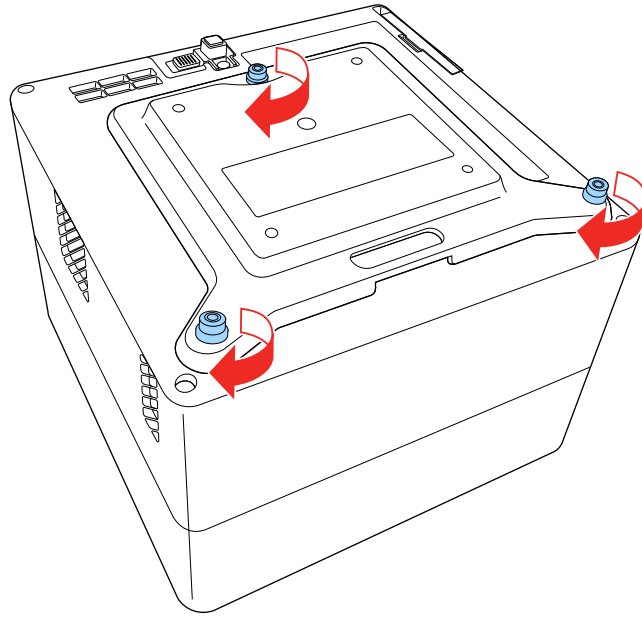

**Caution:** Do not use the feet you removed in step 2 to attach the mounting plate. They could loosen and cause the projector to fall. Use the screws supplied with the mount plate (M4 × 6 mm max. depth).

5. Install the projector onto the mounting hardware or a tripod. For details, see the documentation supplied with the mount or tripod.

**Caution:** When installing the projector on the mount or tripod, make sure you tighten the screws securely. If you place the projector upside down, the screws could loosen and the projector could fall.

When installing the projector in a high location using the safety wire set, make sure you attach the carabiner to a point that is strong enough to support the weight of the projector and mounting hardware.

6. If necessary, mount the AC adapter on the wall or ceiling using the AC adapter holder that is included with the mounting plate.

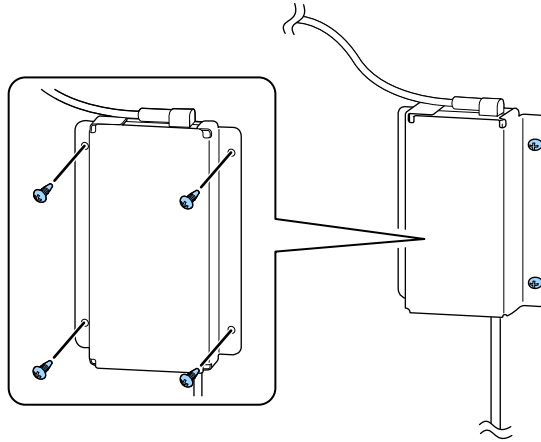

**Caution:** Install the AC adapter at least 11.8 inches (30 cm) away from the projector. If the temperature of the AC adapter rises due to heat from the projector, the projector may not operate properly.

**Note:** When mounting the AC adapter on the wall or ceiling, use screws suitable for the material of the wall or ceiling. If you are unsure what screws to use, consult a professional.

**Parent topic:** [Projector Placement](#)

#### **Related references**

[Projector Parts - Base](#)

[Optional Equipment and Replacement Parts](#)

## **Projector Connections**

See these sections to connect the projector to a variety of projection sources.

**Caution:** Check the shape and orientation of the connectors on any cable you plan to connect. Do not force a connector into a port if it does not fit. The device or your projector could be damaged or could malfunction.

[Connecting to an HDMI Video Source](#)



**Note:** The projector's audio out port only supports 3-pin stereo headphones using a 3.5-mm mini-stereo cable. If you use any other type of headphones, audio may not be output normally.

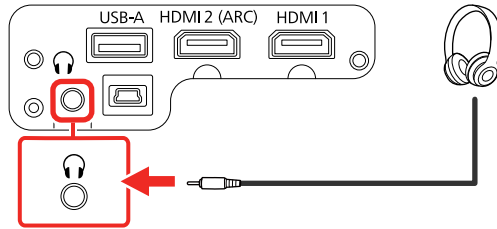

Parent topic: [Projector Connections](#)

## Connecting External Speakers Using HDMI ARC

If your external speakers or A/V receiver are HDMI ARC-compatible, you can connect them to the projector's **HDMI2 (ARC)** port using an optional HDMI cable. Make sure the **HDMI2 ARC** setting is enabled and **ARC** is selected as the **Sound Output Device** setting.

**Note:** If the **HDMI2 ARC** setting is enabled, the projector's internal speakers are disabled.

If you want to output higher-quality audio, select **Auto** as the **Sound Output Format** setting in the **Sound** menu.

1. Connect the HDMI cable to the ARC-compatible HDMI port on your external speakers or A/V receiver.
2. Connect the other end to the **HDMI2 (ARC)** port on the rear of the projector.

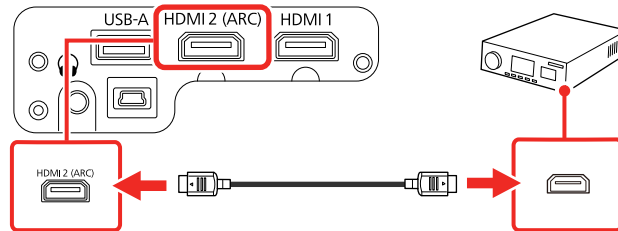

Parent topic: [Projector Connections](#)

### Related references

[Sound Quality Settings - Sound Menu](#)

## Installing Batteries in the Remote Control

The remote control uses the two AAA batteries that came with the projector.

**Caution:** Use only the type of batteries specified in this manual. Do not install batteries of different types, or mix new and old batteries.

1. Remove the battery cover.

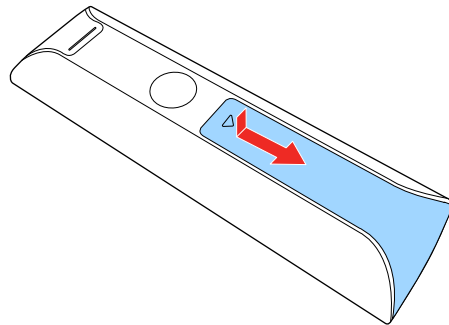



2. Insert the batteries with the + and – ends facing as shown.

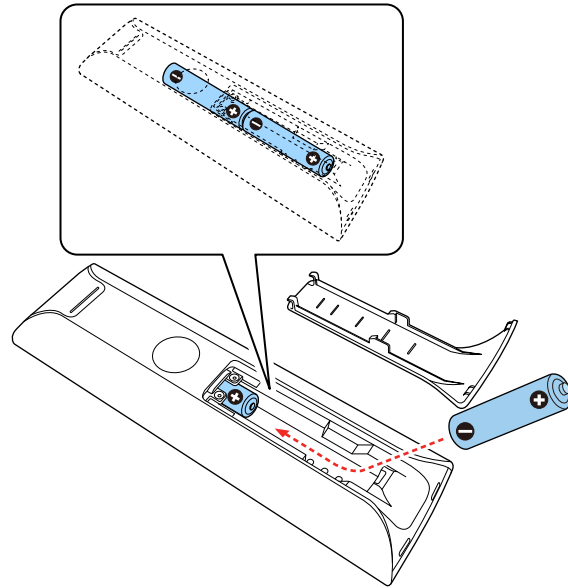

**Warning:** Make sure the batteries are inserted in the correct positions. If the batteries are not inserted correctly, they could explode or leak, causing a fire, injury, or damage to the product.

3. Replace the battery cover and press it down until it clicks into place.

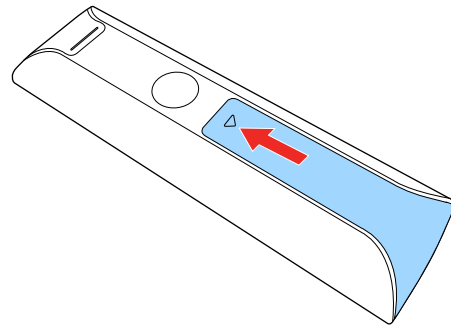



**Warning:** Dispose of used batteries according to local regulations. Do not expose batteries to heat or flame. Keep batteries out of the reach of children; they are choking hazards and are very dangerous if swallowed.

Parent topic: [Setting Up the Projector](#)

## Setting Up Android TV

Android TV must be set-up when you turn on the projector for the first time.

**Note:** After initial setup, you can change the settings by selecting the  icon at the top right of the Android TV Home screen.

1. Press the  Power button on the projector or remote control.
2. When the pairing screen is displayed, press and hold the **Enter** and  Home remote control buttons at the same time.

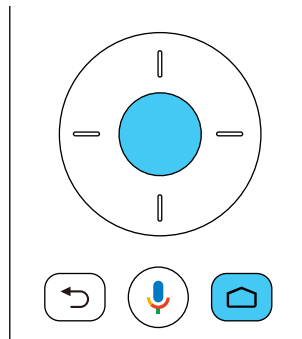

The light on the remote control flashes until pairing is complete.

3. Use the remote control arrow and **Enter** buttons to select the language you want to use from the language selection screen.
4. Do one of the following:
  - Select **Continue** to use an Android phone to set-up the projector's Wi-Fi and Google account settings. Follow the on-screen instructions and skip to step 7.
  - Select **Skip** to set-up the projector's Wi-Fi and Google account settings manually. Go to the next step.

5. Select the wireless network you want to use from the Wi-Fi setting screen and then follow the on-screen instructions to make any necessary settings.
6. At the Google account sign-in screen, do one of the following:
  - Select **Sign In** to sign-in to your Google account. Follow the on-screen instructions.
  - Select **Skip** to use the projector without signing in to a Google account

**Note:** A Google account is required to use certain features.

7. Follow the on-screen instructions to proceed with initial setup, selecting settings as desired. The Home screen is displayed when initial setup is completed.

**Note:** For Android TV support, visit <https://support.google.com/androidtv/>.

**Parent topic:** [Setting Up the Projector](#)

---

# Using Basic Projector Features

Follow the instructions in these sections to use your projector's basic features.

[Turning On the Projector](#)

[Turning Off the Projector](#)

[Projection Modes](#)

[Adjusting the Image Height](#)

[Image Shape](#)

[Remote Control Operation](#)

[Using Voice Commands to Control Your Projector](#)

[Pairing the Remote Control](#)

[Selecting an Image Source](#)

[Using Your Projector as a Chromecast](#)

[Image Aspect Ratio](#)

[Color Mode](#)

[Turning On Automatic Luminance Adjustment](#)

[Adjusting Picture Quality in Detail](#)

[Controlling the Volume with the Volume Buttons](#)

[Changing the Sound Mode](#)

## Turning On the Projector

Turn on the projector before you turn on the video source you want to use.

**Caution:** Do not turn on the video source before connecting it to the projector; otherwise, you may damage the projector.

1. Connect the AC adapter to the projector's power inlet.

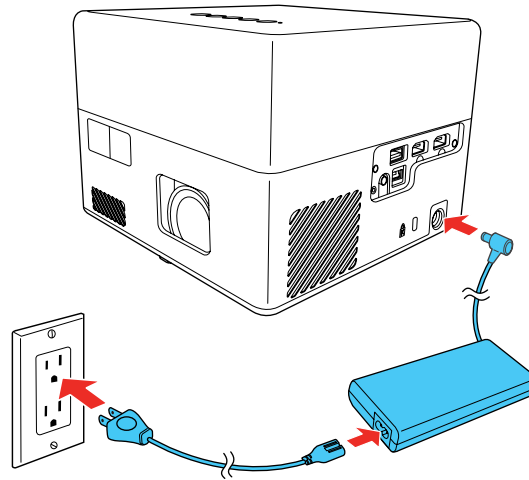

2. Plug the power cord into an electrical outlet and connect it to the AC adapter  
The projector enters standby mode. This indicates that the projector is receiving power, but is not turned on.
3. Press the  Power button on the projector or the projector remote control to turn on the projector.  
The status indicator flashes blue as the projector warms up. After the projector is warmed up, the status light stops flashing and turns blue.

**Warning:** Never look into the projector lens when the light is on. The light can damage your eyes and is especially dangerous for children and pets.

**Caution:** Make sure no objects are blocking the light from the projector lens. Objects blocking the lens for an extended time can melt and light that is reflected back into the lens can cause the projector to malfunction.

The first time you turn on the projector, the remote control pairing screen and initial setup screen are displayed. Follow the on-screen instructions to complete the initial setup.

[Using the Home Screen](#)

**Parent topic:** [Using Basic Projector Features](#)

## Using the Home Screen

You can easily access online content, applications, and projector settings from the Android TV home screen.

1. To display the Home screen, press the  Home button on the remote control.
2. Press the arrow buttons on the remote control to navigate the screen, and press **Enter** to select an option.

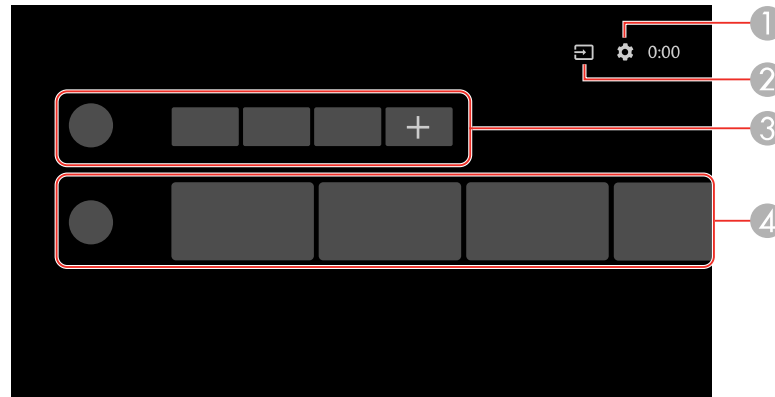

- 1 Displays the Settings menu for Android TV (you can select various settings such as Wi-Fi, language, and Google account information)
- 2 Displays a list of available input sources
- 3 Displays the applications downloaded to your Android TV (add applications to this list by selecting the + icon)
- 4 Displays recommended content from your applications

**Note:** The content of the Home screen may change depending on the Android TV version.

Parent topic: [Turning On the Projector](#)

## Turning Off the Projector

Before turning off the projector, shut down any computer connected to it so you can see the computer display during shutdown.

**Note:** Turn off this product when not in use to prolong the life of the projector. Laser life will vary depending upon mode selected, environmental conditions, and usage. Brightness decreases over time.

**Note:** When using the Blank feature, the laser is still on. To turn off the laser, turn off the projector.

1. Press the power button on the projector or remote control.

The laser turns off and the Status light turns off.

**Note:** You can keep supplying power to the projector by setting the **Power Button Setting** to **Suspend** in the projector's Settings menu. You can then press any button on the projector or remote control to turn on the projector and the projector will also start up faster.

2. To transport or store the projector, make sure the Status light is off, then unplug the power cord.

**Parent topic:** [Using Basic Projector Features](#)

#### **Related references**

[Projector Feature Settings - Settings Menu](#)

[Projector Light Status](#)

## **Projection Modes**

Depending on how you positioned the projector, you may need to change the projection mode so your images project correctly.

- **Standard** (default setting) lets you project from a table in front of the screen or onto the ceiling.
- **Upside Down** flips the image over top-to-bottom to project upside-down from a ceiling or wall mount.

[Changing the Projection Mode Using the Menus](#)

**Parent topic:** [Using Basic Projector Features](#)



## **Changing the Projection Mode Using the Menus**

You can change the projection mode to flip the image over top-to-bottom using the projector menus.

1. Turn on the projector and display an image.
2. Press the  Settings button on the projector remote control.

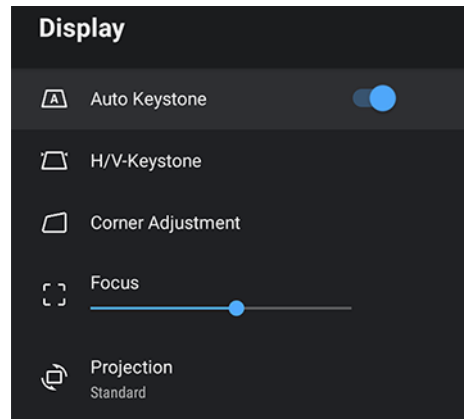
3. Press the arrow buttons to select the **Display** menu and press **Enter**.



4. Select the **Projection** setting and press **Enter**.
5. Select the projection mode you want to use and press **Enter**.
6. Press the  Settings button to exit the menu or the  Esc button to return to the previous screen.

Parent topic: [Projection Modes](#)

## Adjusting the Image Height

If you are projecting from a table or other flat surface and the image is too high or low, you can adjust the image height using the projector's adjustable foot.

1. Turn on the projector and display an image.
2. Press and hold the foot release lever to extend or retract the front adjustable foot.

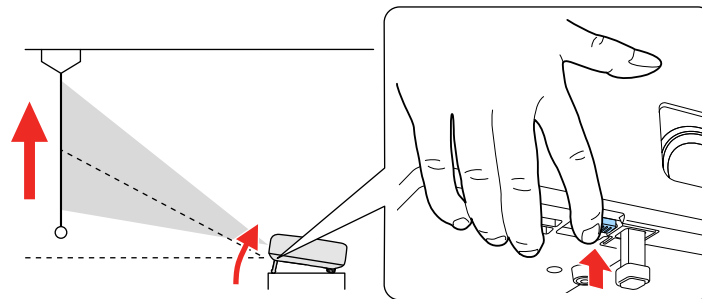



**Note:** You can adjust the position up to 9°.

3. Release the lever to lock the foot when the image is at the position you want.

If the projected image is unevenly rectangular, you need to adjust the image shape.

**Parent topic:** [Using Basic Projector Features](#)

**Related references**

[Projector Feature Settings - Settings Menu](#)

**Related tasks**

[Correcting Image Shape with H/V Keystone](#)

[Correcting Image Shape with Corner Adjustment](#)

## Image Shape

You can project an evenly rectangular image by placing the projector directly in front of the center of the screen and keeping it level. If you place the projector at an angle to the screen, or tilted up or down, or off to the side, you may need to correct the image shape for the best display quality.

When you turn on automatic keystone correction in your projector's Settings menu, your projector automatically corrects keystone effects when you reposition the projector.

You can also press the  Auto Keystone button to automatically correct horizontal and vertical keystone.

Automatic keystone adjustment can occur under the following conditions:

- Screen size is less than 100 inches (250 cm)
- The **Projection** setting is set to **Standard**
- Projection distance is between 28 to 86 inches (0.7 to 2.2 meters)

[Correcting Image Shape with H/V Keystone](#)

[Correcting Image Shape with Corner Adjustment](#)

**Parent topic:** [Using Basic Projector Features](#)

## Correcting Image Shape with H/V Keystone

You can use the projector remote control to correct the shape of an image that is unevenly rectangular on the sides.

**Note:** You can also adjust the keystone settings from the **Display > H/V Keystone** menu.

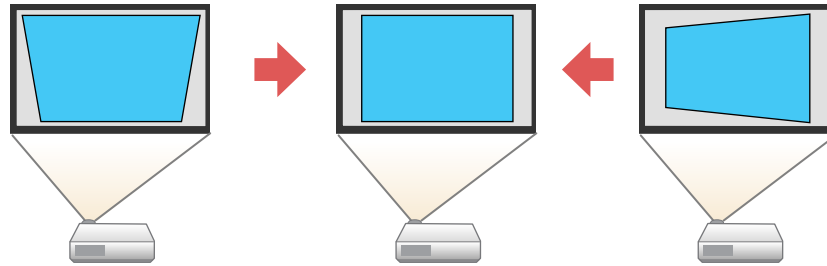

**Note:** You cannot combine **Keystone** correction with other image shape correction methods.

1. Turn on the projector and display an image.
2. Press the  Settings button on the projector remote control.
3. Select **Display > H/V Keystone** and press **Enter**.
4. Use the arrow buttons on the projector remote control to select between vertical and horizontal keystone correction, and to adjust the image shape as necessary.

#### **V-Keystone**

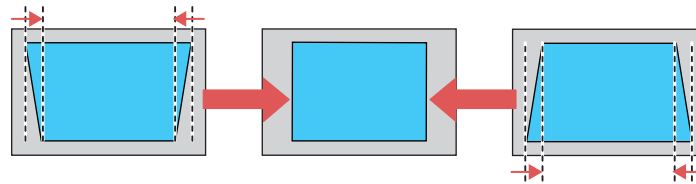

#### **H-Keystone**

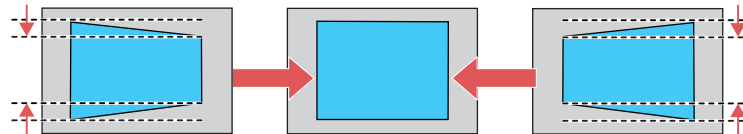

5. Press the ↵ Esc button when you are finished.  
After correction, your image is slightly smaller.

**Parent topic:** [Image Shape](#)

**Related references**

[Projector Feature Settings - Display Menu](#)

## Correcting Image Shape with Corner Adjustment

You can use the projector's Corner Adjustment feature to correct the shape and size of an image that is unevenly rectangular on all sides.

**Note:** To provide the best possible image quality, adjust the projector's position to correct the image shape. If this isn't possible, use the Corner Adjustment feature to correct the image shape.

1. Turn on the projector and display an image.
2. Press the  Auto Keystone button on the remote control.  
The projector runs through the automatic keystone correction sequence.

**Note:** The projector will always run automatic keystone correction when you press the  Auto Keystone button, even if the **Auto Keystone** setting is turned off.

3. Select the **Corner Adjustment** setting.  
You see the Corner Adjustment screen:

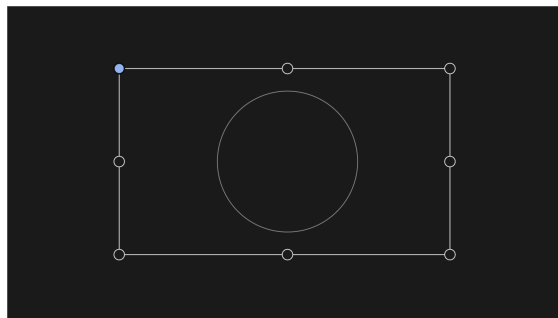

4. Use the arrow buttons on the remote control to select the point on the image you want to adjust. Then press **Enter**.
5. Press the arrow buttons to adjust the image shape as necessary.

**Note:** If the direction key on the screen turns gray, you cannot make further adjustments in that direction.

6. Press the  $\leftarrow$  Esc button on the remote control to return to the point selection screen.
7. Repeat steps 4-6 to adjust any other points.
8. When you are finished, press the  $\leftarrow$  Esc button to exit.

You may see a light shadow around the screen or projected image. This is normal.

**Parent topic:** [Image Shape](#)

**Related references**

[Projector Feature Settings - Display Menu](#)

## Remote Control Operation

The remote control lets you control the projector from almost anywhere in the room, up to 16.4 feet (5 m) away. You can point it at the front or back of the projector.

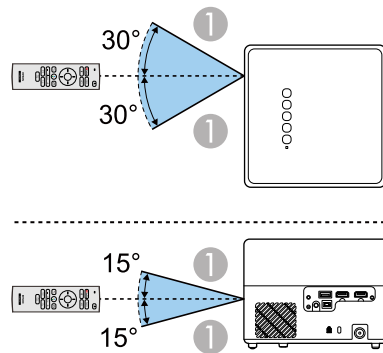

1 16.4 feet (5 m)

**Note:** Avoid using the remote control in conditions with bright fluorescent lights or in direct sunlight, or the projector may not respond to commands. If you will not use the remote control for a long time, remove the batteries.

**Parent topic:** [Using Basic Projector Features](#)

## Using Voice Commands to Control Your Projector

You can use your remote control or linked Google Home device to control your projector using voice commands.

**Note:** Make sure the remote control is paired to the projector.

1. To use voice commands with your projector using your remote, press and release the  mic button, then say the command you want to perform.

You can use voice commands to search for actors or shows, open installed apps, and control media playback.

2. To use a Google Home device to send voice commands to your projector, link the device with your projector using the Google Home app. You may also need to link streaming apps to your Google account. For detailed instructions, go to your device's support page.

**Parent topic:** [Using Basic Projector Features](#)

## Pairing the Remote Control

To use Android TV and video-on-demand features, you must pair the remote control to the projector.

**Note:** When you first turn on the projector, instructions for pairing the remote control are displayed on the screen.

1. Turn on the projector.
2. When the pairing screen is displayed, press and hold the  Home and **Enter** buttons on the remote control until the indicator starts blinking.

A message appears on the screen when the remote control is paired.

**Parent topic:** [Using Basic Projector Features](#)

## Selecting an Image Source

If you connected multiple image sources to the projector, such as a computer and DVD player, you may want to switch from one image source to the other.

1. Make sure the connected image source you want to use is turned on.
2. For video image sources, insert a DVD or other video media and press its play button, if necessary.
3. Press the  Source Search button on the remote control. Press the up or down buttons to select the image source.

**Note:** If no image signal is detected, check the cable connections between the projector and the image source.

**Parent topic:** [Using Basic Projector Features](#)

### Related references

[Solutions When "No Signal" Message Appears](#)

## Using Your Projector as a Chromecast

Your projector has Chromecast built-in, allowing you to cast content from Chromecast-enabled apps.

1. Connect your device or computer to the same wireless network as the projector.
2. Open the Chromecast-enabled app and press the  Cast button.
3. Select your projector from the list of devices.

**Note:** By default, the name of the projector is Projector. To select another name or use a custom name, select the  Settings icon on the Home screen.

The app connects and starts casting to the projector.

4. To stop casting, press the  Cast button in the app and choose the disconnect option.

**Parent topic:** [Using Basic Projector Features](#)

## Image Aspect Ratio

The projector can display images in different width-to-height ratios called aspect ratios. Normally the input signal from your video source determines the image's aspect ratio. However, for certain images

you can change the aspect ratio to fit your screen. If you cannot change the aspect ratio using the projector menus, check the settings on your video source.

### [Changing the Image Aspect Ratio](#)

#### [Available Image Aspect Ratios](#)

**Parent topic:** [Using Basic Projector Features](#)

## Changing the Image Aspect Ratio

You can change the aspect ratio of the displayed image to resize it.

1. Turn on the projector and switch to the image source you want to use.
2. Press the  Settings button on the remote control.
3. Select the **Picture** menu and press **Enter**.

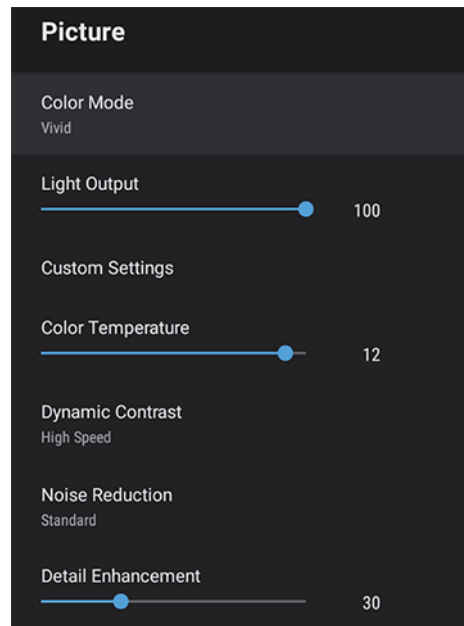

4. Select **Aspect Ratio** and press **Enter**.
5. Select the aspect ratio setting you want to use for your input signal and press **Enter**.
6. Press the  Esc button to exit the menus.

**Parent topic:** [Image Aspect Ratio](#)

**Related references**

[Available Image Aspect Ratios](#)

## Available Image Aspect Ratios

You can select the following image aspect ratio settings, depending on the input signal from your image source.

**Note:** You may see a light shadow around the screen or projected image. This is normal.

**Note:** Using the aspect ratio function to reduce, enlarge, or split the projected image for commercial purposes or for public viewing may infringe upon the rights of the copyright holder of that image based on copyright law.

Aspect ratio setting	Description
<b>Normal</b>	Displays images using the full projection area and maintains the aspect ratio of the image.
<b>Zoom</b>	Displays images using the full width of the projection area and maintains the aspect ratio of the image.
<b>Full</b>	Displays images using the full width of the projection area, but does not maintain the aspect ratio.

**Parent topic:** [Image Aspect Ratio](#)

## Color Mode

The projector offers different Color Modes to provide optimum brightness, contrast, and color for a variety of viewing environments and image types. You can select a mode designed to match your image and environment, or experiment with the available modes.

If you always want to use a particular color mode for a certain video input source, you can select it using the projector menus.

[Changing the Color Mode](#)

[Available Color Modes](#)

**Parent topic:** [Using Basic Projector Features](#)



## Changing the Color Mode

You can change the projector's Color Mode to optimize the image for your viewing environment.

1. Turn on the projector and switch to the image source you want to use.
2. If you are projecting from a DVD player or other video source, insert a disc or other video media and press the play button, if necessary.
3. Press the  Settings button on the remote control.
4. Select the **Picture** menu and press **Enter**.

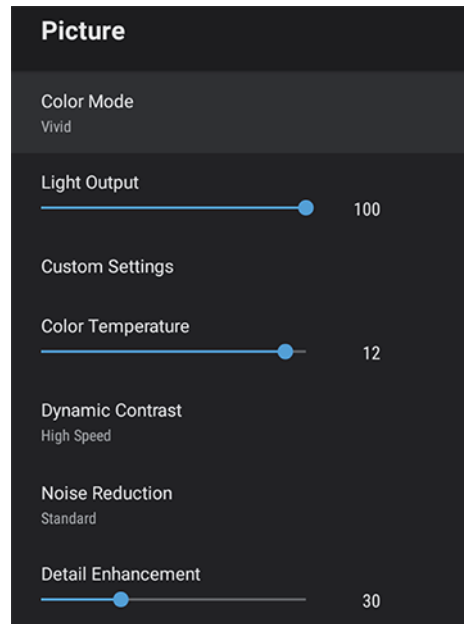

5. Select **Color Mode** and press **Enter**.
6. Press the arrow buttons to select a color mode setting and press **Enter**.
7. When you are finished, press  Esc.

Parent topic: [Color Mode](#)

## Available Color Modes

You can set the projector to use these Color Modes, depending on the input source you are using:

Color Mode	Description
Dynamic	Best for optimizing brightness
Vivid	Best for projecting general content in a bright environment
Bright Cinema	Best for projecting movies in a bright environment
Cinema	Best for projecting movies in a dark environment
Natural	Best for projecting the image as is (choose this mode when making color adjustments)

Parent topic: [Color Mode](#)

## Turning On Automatic Luminance Adjustment

You can turn on the **Dynamic Contrast** setting to automatically optimize the image luminance. This improves the image contrast based on the brightness of the content you project.

1. Turn on the projector and switch to the image source you want to use.
2. Press the  Settings button on the remote control.

3. Select the **Picture** menu and press **Enter**.

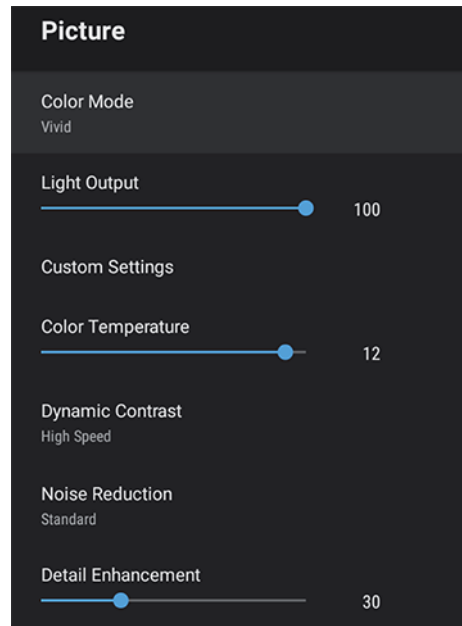

4. Select the **Dynamic Contrast** setting and press **Enter**.
5. Select one of the following options and press **Enter**.
  - **Normal** to adjust brightness at the standard speed.
  - **High Speed** to adjust brightness as soon as the scene changes.
6. Press the ↵ Esc button to exit the menus.

**Parent topic:** [Using Basic Projector Features](#)

## Adjusting Picture Quality in Detail

You can fine-tune the image details using the projector menus.

1. Turn on the projector and switch to the image source you want to use.
2. Press the  Settings button on the remote control.

3. Select the **Picture** menu and press **Enter**.

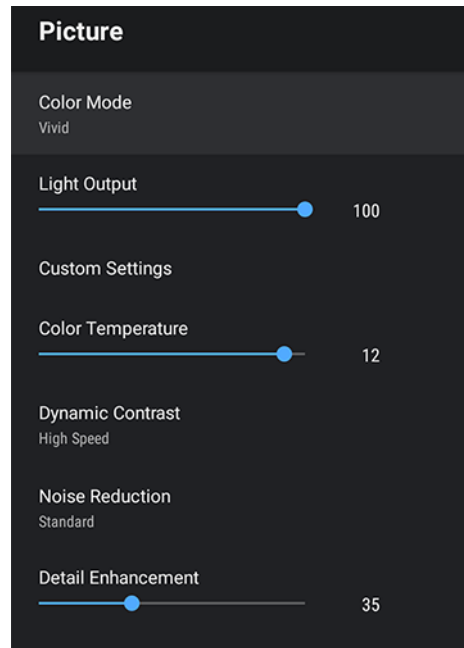

4. Select the **Custom Settings** setting and press **Enter**.
5. Select one of the following options and press **Enter**.
  - **Brightness**: Adjusts overall color brightness
  - **Contrast**: Adjusts the difference between light and dark areas of the image
  - **Saturation**: Adjusts the overall color density
  - **Tint**: Adjusts the balance of green and magenta in the image
  - **Sharpness**: Adjusts the outline of the image
6. Press the **↵** Esc button to exit the menus.

**Parent topic:** [Using Basic Projector Features](#)

## Controlling the Volume with the Volume Buttons

You can use the **Volume** buttons on the projector or the remote control to adjust the volume of your projected content. The volume buttons control the projector's internal speaker system or any external speakers you connected to the projector.

You must adjust the volume separately for each connected input source.

**Warning:** Do not start playback at a high volume. Sudden loud noises may cause hearing loss. Always lower the volume before turning off the projector. Gradually increase the volume after turning the projector on.

1. Turn on the projector and start a presentation that includes audio.
2. To lower or raise the volume, press the volume buttons on the projector's control panel or remote control.

**Parent topic:** [Using Basic Projector Features](#)



## Changing the Sound Mode

You can change the projector's sound mode to provide optimal sound for a variety of image types.

1. Turn on the projector and start a video.
2. Press the  Settings button on the remote control.

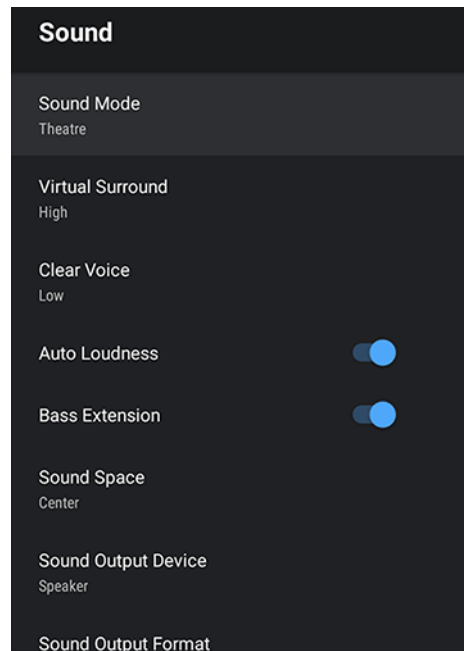
3. Press the arrow buttons to select the **Sound** menu and press **Enter**.



4. Select the **Sound Mode** setting and press **Enter**.
5. Select a sound mode and press **Enter**.
6. Press the  Settings button to exit the menu or the  Esc button to return to the previous screen.

[Available Sound Modes](#)

**Parent topic:** [Using Basic Projector Features](#)

## Available Sound Modes

You can set the projector to use these sound modes, depending on the input source you are using:

Color Mode	Description
Theatre	Mimics the acoustics of a theater environment; best used for watching movies

<b>Color Mode</b>	<b>Description</b>
<b>TV</b>	Clearly plays back voices for content such as news and documentaries; best used for watching TV shows
<b>Studio</b>	Reproduces sound with a wide frequency and balanced sound quality to mimic a studio environment; best used for listening to music
<b>Stadium</b>	Emphasizes voices and recreates the atmosphere of stadiums and crowds. Best used for watching sports.
<b>Concerts</b>	Mimics the acoustics of a concert venue; best used for listening to live music performances
<b>Karaoke Mode</b>	Accentuates combined vocals and music. Allows you to play songs while using effects provided by karaoke apps and microphones.

**Parent topic:** [Changing the Sound Mode](#)

---

# Adjusting Projector Features

Follow the instructions in these sections to use your projector's feature adjustments.

[Using the Projector as a Bluetooth Speaker](#)

[Operating Connected Devices Using the HDMI Link Features](#)

[Shutting Off the Picture Temporarily](#)

[Updating the Firmware](#)

[Resetting the Projector](#)

## Using the Projector as a Bluetooth Speaker

You can use the projector's speakers to output audio from a compatible device connected by Bluetooth.

**Note:** Bluetooth audio devices are not supported in some countries and regions. You cannot connect multiple audio/video devices by Bluetooth at the same time. You may not be able to connect depending on type of device and its Bluetooth standards. Several attempts may be required before pairing is successful. Even when connecting within the specified communication distance, connections can be lost due to the signal status.

1. Press the  Bluetooth Speaker mode button on the projector or remote control to turn on Bluetooth Speaker mode.

You see a confirmation on the screen.

2. Enable the Bluetooth function on the device you want to connect to and select **Projector** from the available device list. See the documentation for the connected device for more information.

**Note:** There is a delay in the audio output from any Bluetooth audio device. If you want to temporarily turn off the projected image, press the  Blank button on the projector or remote control. To cancel a Bluetooth connection, disconnect from the connected device.

3. To exit Bluetooth Speaker mode, press the  Bluetooth Speaker mode button again.

**Note:** While the projector is in Bluetooth Speaker mode, you can connect input devices such as smartphones or tablets, but you cannot pair output devices such as headphones or external speakers. If you are having trouble pairing speakers or headphones, make sure the Bluetooth Speaker mode is disabled.



You see a confirmation on the screen.

**Parent topic:** [Adjusting Projector Features](#)

## Operating Connected Devices Using the HDMI Link Features

You can use the remote control to control certain features of devices connected to the projector's HDMI ports.

**Note:** You must use an HDMI cable that supports the CEC standard and the connected device must also be configured. Some connected devices or functions of those devices may not operate properly even though they meet the HDMI CEC standard. See the documentation supplied with the device for more information.

1. Press the  Settings button on the remote control.
2. Select the **Settings** menu and press **Enter**.

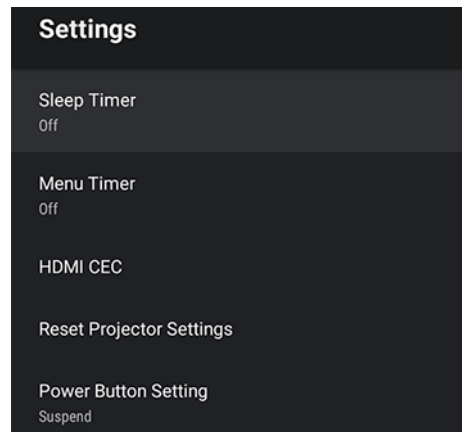

3. Select **HDMI CEC** and press **Enter**.
4. Select the **HDMI CEC** setting and press **Enter** to enable it, if necessary.
5. Select the following HDMI link options as necessary:
  - **Device Auto Power Off:** select whether to automatically turn off the connected device when you turn off the projector.

- **Auto Language Change:** select whether to switch the language settings of the connected device to match the projector's language settings.
- **HDMI2 ARC:** select whether to output audio to an HDMI ARC compatible audio/video system.

6. When you are finished, press ↵ Esc.

**Parent topic:** [Adjusting Projector Features](#)

## Shutting Off the Picture Temporarily

You can temporarily turn off the projected picture if you want to redirect your audience's attention during a presentation. Any sound or video action continues to run, however, so you cannot resume projection at the point that you stopped it.

1. Press the  Blank button on the projector or remote control to temporarily stop projection.

The light source turns off and projection is interrupted.

2. To turn the picture back on, press the  Blank button again.

**Parent topic:** [Adjusting Projector Features](#)

## Updating the Firmware

You can get the latest version of the projector firmware over a network.

When the latest projector firmware is available, a notification is automatically displayed on the screen. Follow the on-screen instructions to update the firmware.

1. Press the **Apps** button on the remote control.

You see a menu like this:

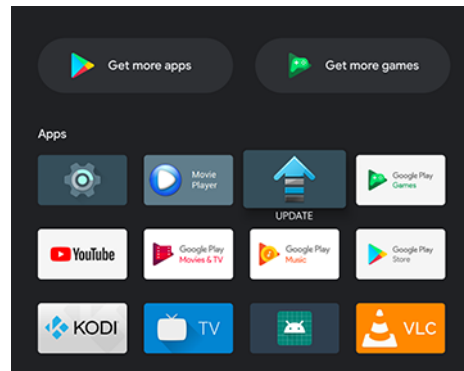

2. Select **UPDATE** from the application list and press **Enter**.
3. Follow the on-screen instructions to update the firmware.



**Caution:** Do not turn off the projector while updating the firmware.

**Parent topic:** [Adjusting Projector Features](#)

## Resetting the Projector

You can reset the projector and all settings to their default values.

**Note:** Write down the settings you do not want to lose before resetting the projector. When you reset the projector, all information, including installed apps, Google account login information, and Projector Settings, is deleted.

1. Press the  Home button on the remote control.
2. Select the  icon at the top right of the Android TV Home screen and press **Enter**.
3. Select **Device Preferences** and press **Enter**.
4. Select **Reset** and press **Enter**.  
A confirmation screen is displayed.
5. Select **Reset** and press **Enter** to reset the projector.

**Parent topic:** [Adjusting Projector Features](#)

---

# Adjusting the Menu Settings

Follow the instructions in these sections to access the projector menu system and change projector settings.

[Using the Projector's Menus](#)

[Image Quality Settings - Picture Menu](#)

[Sound Quality Settings - Sound Menu](#)

[Projector Feature Settings - Display Menu](#)

[Projector Feature Settings - Settings Menu](#)

## Using the Projector's Menus

You can use the projector's menus to adjust the settings that control how your projector works. The projector displays the menus on the screen.

1. Press the  Settings button on the remote control.

You see the Projector Settings menu.

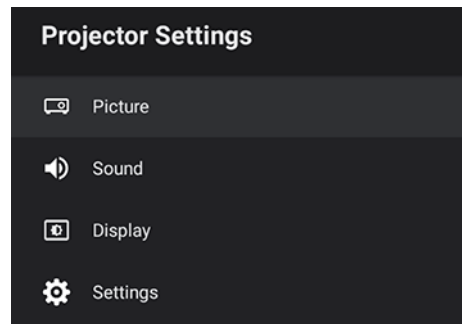

2. Press the up or down arrow button on the remote control to move through the menu selections.
3. To change settings in the displayed menu, press **Enter**.
4. Use the arrow and **Enter** buttons to adjust the menu settings as desired.
5. When you finish changing settings on a menu, press  Esc to exit the menus.

**Parent topic:** [Adjusting the Menu Settings](#)

## Image Quality Settings - Picture Menu

Settings on the Picture menu let you adjust the quality of your image for the input source you are currently using.

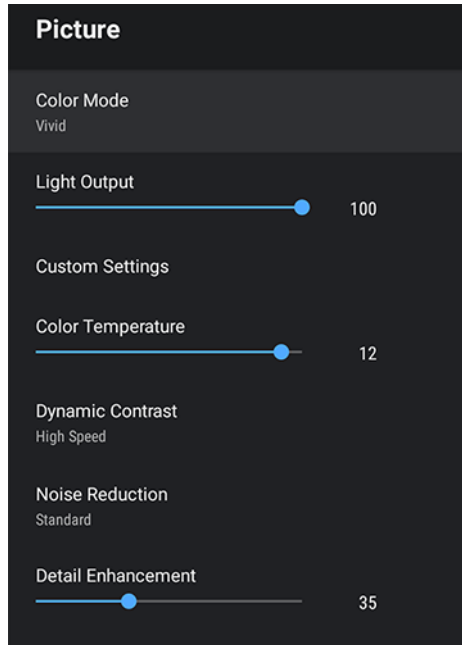

Setting	Options	Description
<b>Color Mode</b>	See the list of available Color Modes	Adjusts the vividness of image colors for various image types and environments
<b>Light Output</b>	Varying levels available	Sets the brightness for the light source for each Color Mode

Setting	Options	Description
<b>Custom Settings</b>	<b>Brightness</b> <b>Contrast</b> <b>Saturation</b> <b>Tint</b> <b>Sharpness</b> <b>Scene Adaptive Gamma</b>	<b>Brightness:</b> Lightens or darkens the overall image <b>Contrast:</b> Adjusts the difference between light and dark areas of the image <b>Saturation:</b> Adjusts the intensity of the image colors <b>Tint:</b> Adjusts the balance of green to magenta tones in the image <b>Sharpness:</b> Adjusts the sharpness or softness of image details <b>Scene Adaptive Gamma:</b> Adjusts the gamma depending on the displayed scene
<b>Color Temperature</b>	Varying levels available	Sets the color temperature according to the selected color mode; lower values tint the image red, and higher values tint the image blue
<b>Dynamic Contrast</b>	<b>Off</b> <b>Normal</b> <b>High Speed</b>	Adjusts the projected luminance based on the image brightness when certain Color Modes are selected
<b>Noise Reduction</b>	<b>Strong</b> <b>Standard</b> <b>Weak</b> <b>Off</b>	Reduces flickering in analog images
<b>Detail Enhancement</b>	Varying levels available	Creates a more textured image

Setting	Options	Description
<b>Aspect Ratio</b>	<b>Normal</b> <b>Full</b> <b>Zoom</b>	Sets the aspect ratio for the selected input source
<b>HDMI Video Range</b>	<b>Auto</b> <b>Full</b> <b>Limited</b>	Sets the video range to match the setting of the device connected to the HDMI input port

Parent topic: [Adjusting the Menu Settings](#)

## Sound Quality Settings - Sound Menu

Settings on the Sound menu allow you to optimize the audio for a variety of projected content. You can select from presets or experiment with available modes.

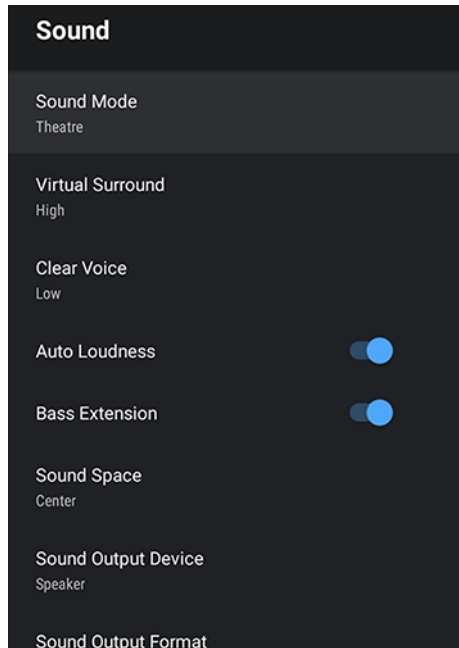

Setting	Options	Description
<b>Sound Mode</b>	<b>Theatre</b> <b>TV</b> <b>Studio</b> <b>Stadium</b> <b>Concert</b> <b>Karaoke Mode</b>	Sets a sound mode for the type of playback content (music, movie, etc.)
<b>Virtual Surround</b>	<b>High</b> <b>Low</b> <b>Off</b>	Adjusts the strength of the surround effect. This setting is saved for each Sound Mode
<b>Clear Voice</b>	<b>High</b> <b>Low</b> <b>Off</b>	Adjusts output so that voices can be heard clearly. This setting is saved for each Sound Mode
<b>Auto Loudness</b>	<b>On</b> <b>Off</b>	Automatically corrects the balance between high and low tones in the audio so that they are not out of balance, even when playing at low volume
<b>Bass Extension</b>	<b>On</b> <b>Off</b>	Emphasizes the bass levels in the audio output
<b>Sound Space</b>	<b>Right</b> <b>Center</b> <b>Left</b>	Adjusts the sound quality to suit your viewing position
<b>Sound Output Device</b>	<b>Speaker</b> <b>ARC</b>	Selects the sound output device <b>Speaker:</b> Outputs sound from the projector's speakers <b>ARC:</b> Outputs sound from an ARC-compatible AV system. Make sure to connect the AV system to the projector's <b>HDMI2 (ARC)</b> port. Disables internal speakers when selected.



Setting	Options	Description
<b>Sound Output Format</b>	<b>PCM</b> <b>Auto</b>	<p>Selects the sound output format when you output audio to an external audio device</p> <p><b>PCM:</b> Outputs sound in PCM format (2-channel)</p> <p><b>Auto:</b> Outputs higher quality sound. The following codecs are supported:</p> <ul style="list-style-type: none"> <li>• PCM (2 ch)</li> <li>• AC-3 (up to 5.1 ch)</li> <li>• DTS (up to 5.1 ch)</li> </ul> <p>If sound is not output correctly, select <b>PCM</b>.</p>
<b>Audio Output Latency</b>	Varying levels available	<p>Adjusts the audio latency. If the audio is fast, select a higher value. This setting is only available for the following types of audio:</p> <ul style="list-style-type: none"> <li>• audio output from the projector's speaker</li> <li>• audio output from the <b>HDMI2 (ARC)</b> port</li> <li>• audio output from a Bluetooth device</li> </ul> <p><b>Note:</b> This setting will not compensate for delayed audio.</p>

Parent topic: [Adjusting the Menu Settings](#)

## Projector Feature Settings - Display Menu

Settings on the Display menu let you customize the image projection.

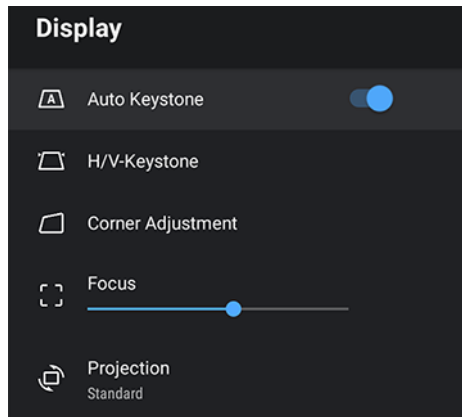

Setting	Options	Description
<b>Auto Keystone</b>	<b>On</b> <b>Off</b>	Select <b>On</b> to automatically correct focus and image keystone if you move the projector
<b>H/V Keystone</b>	<b>H-Keystone</b> <b>V-Keystone</b>	Lets you manually correct the angles of the horizontal and vertical sides
<b>Corner Adjustment</b>	—	Corrects image shape and alignment using an on-screen display
<b>Focus</b>	—	Manually overrides the automatic keystone settings
<b>Projection</b>	<b>Standard</b> <b>Upside Down</b>	Flips the image to match the orientation of the projector

Parent topic: [Adjusting the Menu Settings](#)

## Projector Feature Settings - Settings Menu

Options on the Settings menu let you customize various projector features.

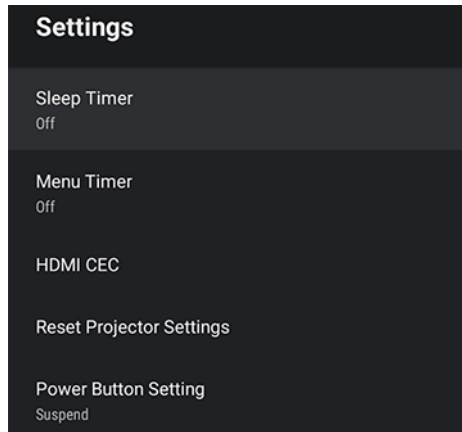

Setting	Options	Description
<b>Sleep Timer</b>	<b>Off</b> <b>15min.</b> <b>30min.</b> <b>45min.</b> <b>60min.</b> <b>90min.</b> <b>120min.</b>	Sets the interval before the projector automatically turns off; if canceled during on-screen countdown, setting will be changed to <b>Off</b>
<b>Menu Timer</b>	<b>Off</b> <b>15sec.</b> <b>30sec.</b> <b>60sec.</b> <b>120sec.</b> <b>240sec.</b>	Sets the interval before automatically closing the projector's menu

Setting	Options	Description
<b>HDMI CEC</b>	<b>HDMI CEC</b> <b>Device Auto Power Off</b> <b>Auto Language Change</b> <b>HDMI2 ARC</b>	<p>Adjusts the HDMI CEC options that allow the projector remote to control HDMI-connected devices that support the CEC standard</p> <p><b>HDMI CEC:</b> allows for control of the connected device using the projector's remote control. If this setting is <b>On</b>, the projector automatically turns on when the device is turned on or playback is started on the device</p> <p><b>Device Auto Power Off:</b> automatically turns off the connected device when you turn off the projector</p> <p><b>Auto Language Change:</b> automatically switches the language settings of the connected device according to the projector's language setting</p> <p><b>HDMI2 ARC:</b> enables HDMI ARC on the <b>HDMI2 (ARC)</b> port</p> <p><b>Note:</b> To select the <b>HDMI2 (ARC)</b> port as the audio output device, select <b>ARC</b> as the <b>Sound Output Device</b> setting in the Sound menu.</p>
<b>Reset Projector Settings</b>	—	Resets the projector's menu settings to their factory defaults

Setting	Options	Description
<b>Power Button Setting</b>	<b>Suspend</b> <b>Shutdown</b>	Sets the operation performed by the projector when you press the power button  <b>Suspend:</b> starts the projector quickly from standby mode  <b>Shutdown:</b> minimizes power consumption in standby mode but takes longer to start the projector

Parent topic: [Adjusting the Menu Settings](#)

---

# Maintaining and Transporting the Projector

Follow the instructions in these sections to maintain your projector and transport it from place to place.

[Projector Maintenance](#)

[Air Filter and Vent Maintenance](#)

[Replacing the Remote Control Batteries](#)

[Transporting the Projector](#)

## Projector Maintenance

Your projector needs little maintenance to keep working at its best.

You may need to clean the projector lens periodically, and clean the air filter and air vents to prevent the projector from overheating due to blocked ventilation.

The only parts you should replace are the air filter and remote control batteries. If any other part needs replacing, contact Epson or an authorized Epson servicer.

If you have to send your projector in for service, you should reset your projector settings. See the link below.

This projector uses a sealed laser light source which does not need servicing and cannot be replaced.

**Warning:** Before cleaning any part of the projector, turn it off and unplug the power cord. Never open any cover on the projector, except as specifically explained in this manual. Dangerous electrical voltages in the projector can injure you severely.

**Warning:** Do not try to service this product yourself, except as specifically explained in this manual. Refer all other servicing to qualified servicers.

[Cleaning the Lens](#)

[Cleaning the Projector Case](#)

**Parent topic:** [Maintaining and Transporting the Projector](#)

### Related references

[Where to Get Help \(U.S. and Canada\)](#)

[Where to Get Help \(Latin America\)](#)

### Related tasks

[Resetting the Projector](#)

## [Turning Off the Projector](#)

### **Cleaning the Lens**

Clean the projector's lens periodically, or whenever you notice dust or smudges on the surface.

- To remove dust or smudges, gently wipe the lens with lens-cleaning paper.
- To remove stubborn smudges, moisten a soft, lint-free cloth with lens cleaner and gently wipe the lens. Do not spray any liquid directly on the lens.

**Warning:** Do not use a lens cleaner that contains flammable gas. The high heat generated by the projector may cause a fire.

**Caution:** Do not use glass cleaner or any harsh materials to clean the lens and do not subject the lens to any impacts; you may damage it. Do not use canned air, or the gases may leave a residue. Avoid touching the lens with your bare hands to prevent fingerprints on or damage to the lens surface.

**Parent topic:** [Projector Maintenance](#)

### **Cleaning the Projector Case**

Before cleaning the projector case, turn off the projector and unplug the power cord.

- To remove dust or dirt, use a soft, dry, lint-free cloth.
- To remove stubborn dirt, use a soft cloth moistened with water and mild soap. Do not spray liquid directly on the projector.

**Caution:** Do not use wax, alcohol, benzene, paint thinner, or other chemicals to clean the projector case. These can damage the case. Do not use canned air, or the gases may leave a flammable residue.

**Parent topic:** [Projector Maintenance](#)

#### **Related tasks**

[Turning Off the Projector](#)

### **Air Filter and Vent Maintenance**

Regular filter maintenance is important to maintaining your projector. Your Epson projector is designed with an easily accessible, user-replaceable filter to protect your projector and make regular maintenance simple. Filter maintenance intervals will depend on the environment.

If regular maintenance is not performed, your Epson projector will notify you when the temperature inside the projector has reached a high level. Do not wait until this warning appears to maintain your projector filter as prolonged exposure to high temperatures may reduce the life of your projector or laser.

Damage due to the failure to properly maintain the projector or its filter may not be covered by the projector's Limited Warranty.

[Cleaning the Air Filter and Vents](#)

[Replacing the Air Filter](#)

**Parent topic:** [Maintaining and Transporting the Projector](#)

## Cleaning the Air Filter and Vents

Clean the projector's air filter or vents if they get dusty, or if you see a message telling you to clean them.

Clean the air filter immediately when the projector displays a message indicating high temperatures inside the projector. It is recommended that you clean the filter every 5000 hours. Clean the filter and vents more frequently if you are using the projector in a dusty or smoky environment.

**Caution:** If you do not perform regular maintenance, the projector will display a high temperature warning. Do not wait until this message appears to clean your air filter and vents, as prolonged exposure to high temperatures can reduce the life of your projector.

1. Turn off the projector and unplug the power cord.
2. Gently remove the dust using a small vacuum designed for computers or a very soft brush (such as a paintbrush).

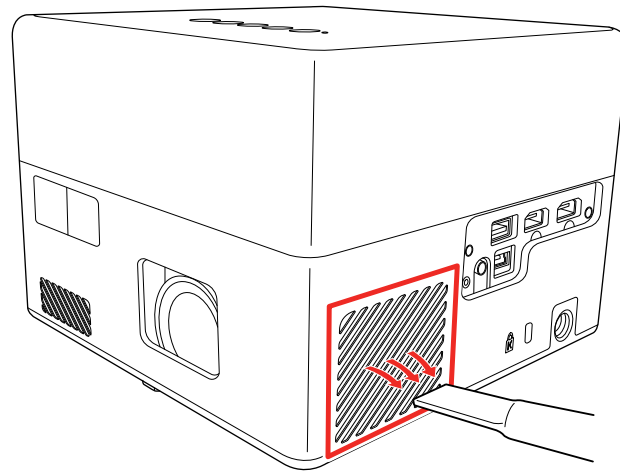



**Note:** You can remove the air filter so you can clean both sides of it. Do not rinse the air filter in water or use any detergent or solvent to clean it.

**Caution:** Do not use canned air. The gases may leave a flammable residue or push dust and debris into the projector's optics or other sensitive areas.

3. If dust is difficult to remove or the air filter is damaged, replace the air filter.

**Parent topic:** [Air Filter and Vent Maintenance](#)

**Related references**

[Projector Light Status](#)

**Related tasks**

[Turning Off the Projector](#)

## Replacing the Air Filter

You need to replace the air filter in the following situations:

- After cleaning the air filter, you see a message telling you to clean or replace it
- The air filter is torn or damaged

You can replace the air filter while the projector is mounted to the ceiling using the optional Epson mounting plate (ELPMB65) or placed upside-down on a table.

1. Turn off the projector and unplug the power cord.
2. Place the projector upside-down on a table.

3. Remove the air filter cover.

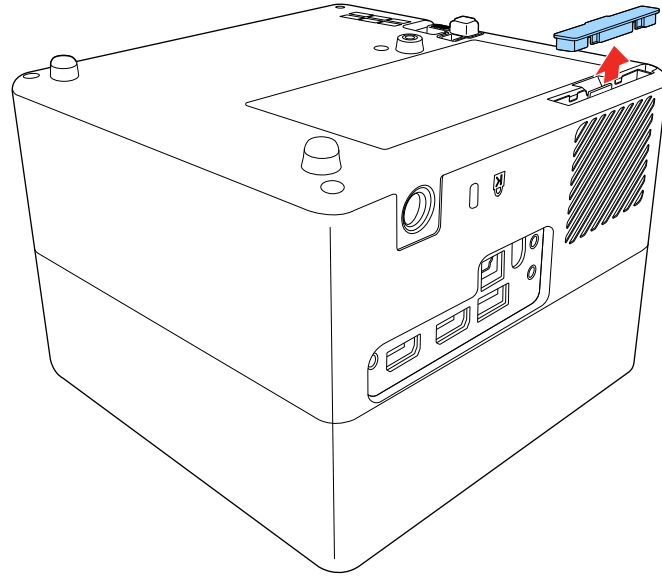

4. Pull the air filter out of the projector.

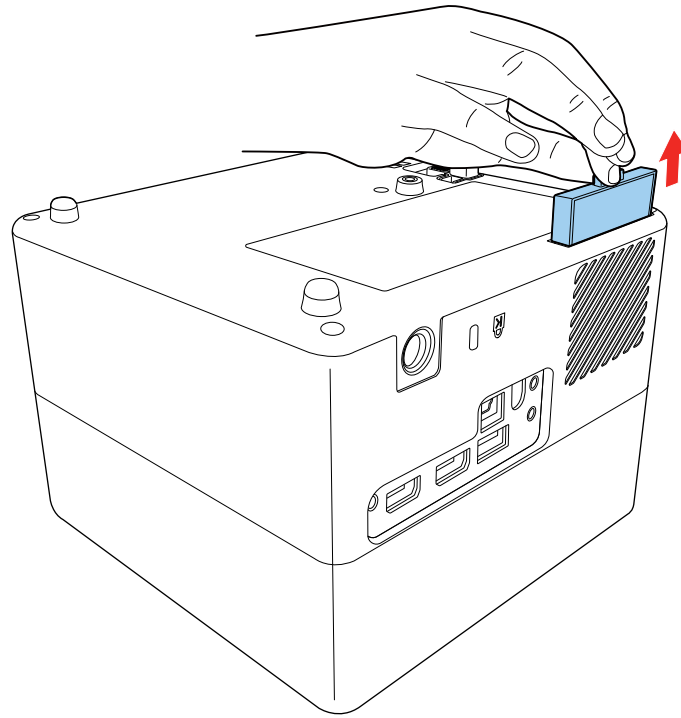

**Note:** Air filters contain ABS resin and polyurethane foam. Dispose of used air filters according to local regulations.

5. Place the new air filter in the projector as shown and push gently until it clicks into place.

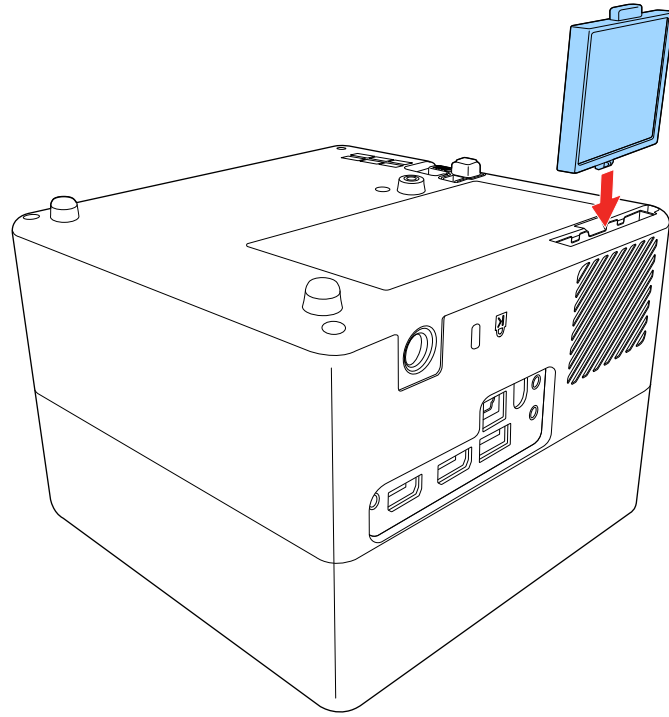

6. Replace the air filter cover.

**Parent topic:** [Air Filter and Vent Maintenance](#)

**Related references**

[Projector Parts - Base](#)

[Optional Equipment and Replacement Parts](#)

[Projector Light Status](#)

**Related tasks**

[Turning Off the Projector](#)

## Replacing the Remote Control Batteries

The remote control uses two AAA manganese or alkaline batteries. Replace the batteries as soon as they run out.

**Caution:** Use only the type of batteries specified in this manual. Do not install batteries of different types, or mix new and old batteries.

1. Remove the battery cover as shown.

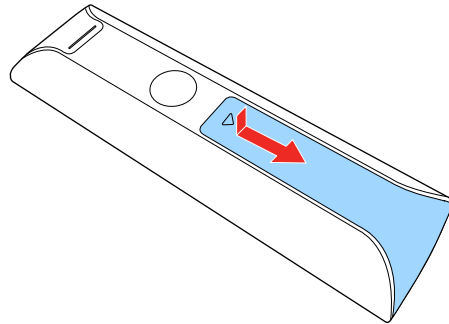

2. Remove the old batteries.

**Warning:** If the battery fluid has leaked, wipe it away with a soft cloth and avoid getting the fluid on your hands. If it gets on your hands, wash them immediately to avoid injury.

3. Insert the batteries with the + and – ends facing as shown.

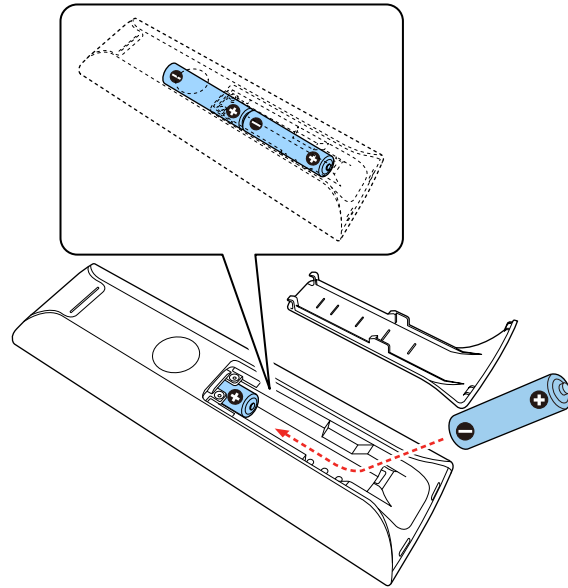

**Warning:** Make sure the batteries are inserted in the correct positions. If the batteries are not inserted correctly, they could explode or leak, causing a fire, injury, or damage to the product.

4. Replace the battery cover and press it down until it clicks into place.

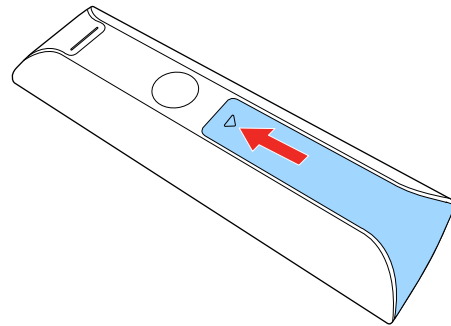

**Warning:** Dispose of used batteries according to local regulations. Do not expose batteries to heat or flame. Keep batteries out of the reach of children; they are choking hazards and are very dangerous if swallowed.

**Parent topic:** [Maintaining and Transporting the Projector](#)

## Transporting the Projector

The projector contains precision parts, some of which are glass. Follow the guidelines here to transport, ship, or store the projector safely.

1. Remove any equipment connected to the projector.
2. Turn off the projector.
3. Make sure the status indicator is not lit, then unplug the power cord.
4. Do one of the following:
  - When transporting the projector a long distance or as checked luggage, pack it in a firm box with cushioning around it and mark the box "Fragile."
  - When shipping the projector for repairs, place it in its original packing materials, if possible, or use equivalent materials with cushioning around the projector. Mark the box "Fragile."

**Note:** We recommend resetting your projector settings (including any account settings) before sending your projector in for service. See the link below.

**Note:** Epson shall not be liable for any damages incurred during transportation.

**Parent topic:** [Maintaining and Transporting the Projector](#)

### Related references

[Projector Light Status](#)

### Related tasks

[Turning Off the Projector](#)

[Resetting the Projector](#)

---

# Solving Problems

Check the solutions in these sections if you have any problems using the projector.

[Projection Problem Tips](#)

[Projector Light Status](#)

[Solving Image or Sound Problems](#)

[Solving Projector or Remote Control Operation Problems](#)

[Solutions to HDMI Link Problems](#)

[Solving Network Problems](#)

[Where to Get Help \(U.S. and Canada\)](#)

[Where to Get Help \(Latin America\)](#)

## Projection Problem Tips

If the projector is not working properly, try turning it off and unplugging it. Then plug it back in and turn it on.

If this does not solve the problem, check the following:

- The lights on the projector may indicate what the problem is.
- The solutions in this manual can help you solve many problems.

If none of these solutions help, you can contact Epson for technical support.

**Parent topic:** [Solving Problems](#)

**Related references**

[Projector Light Status](#)



## Projector Light Status

The lights on the projector indicate the projector status and let you know when a problem occurs. Check the status and color of the lights and look for a solution in the tables here.

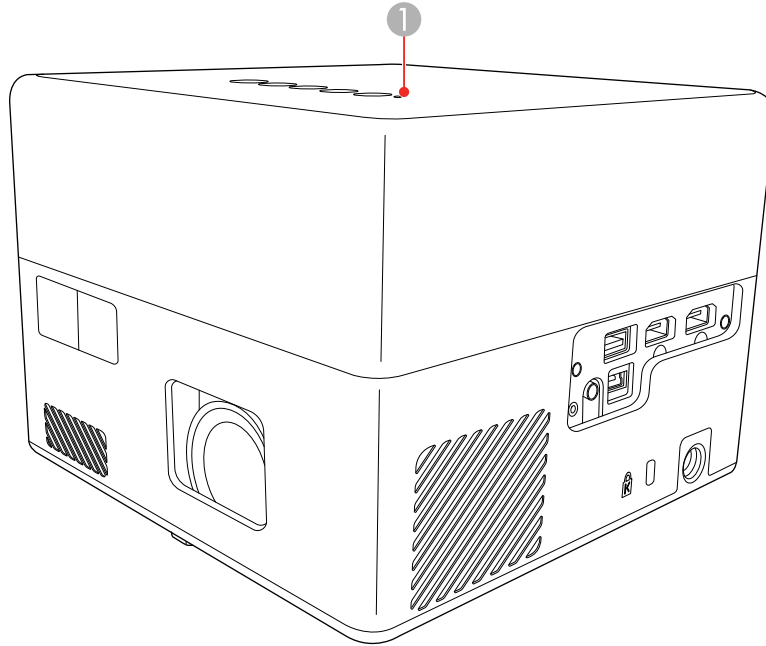

1 Status indicator

Status indicator	Status and solution
Blue	Normal operation
Flashing blue	The projector is warming up, shutting down, or initializing the projector. The remote control may not function if the status indicator is flashing blue.

Status indicator	Status and solution
Off	<p>The projector is in standby or sleep mode. When you press the power button on the projector or remote, projection begins.</p> <ul style="list-style-type: none"> <li>• Make sure that the vents are not clogged with dust or obstructed by nearby objects.</li> <li>• If the problem persists, unplug the projector and contact Epson for help.</li> </ul>
Orange	<p>Projector is too hot and has turned off.</p> <ul style="list-style-type: none"> <li>• Let the projector cool down for at least five minutes</li> <li>• Make sure that the vents and air filter are not clogged with dust or obstructed by nearby objects.</li> <li>• Clean or replace the air filter.</li> <li>• Make sure the environmental temperature is not too hot.</li> <li>• If the problem persists, unplug the projector and contact Epson for help.</li> </ul>
Flashing orange	<p>One of the following has occurred:</p> <ul style="list-style-type: none"> <li>• The laser has a problem</li> <li>• A fan or sensor has a problem</li> <li>• An internal projector error has occurred.</li> </ul> <p>Turn the projector off, unplug it, and contact Epson for help.</p>

**Note:** If the lights display a pattern not listed in the tables above, turn the projector off, unplug it, and contact Epson for help.

**Parent topic:** [Solving Problems](#)

**Related references**

[Projector Environmental Specifications](#)

[Where to Get Help \(U.S. and Canada\)](#)

[Where to Get Help \(Latin America\)](#)

**Related tasks**

[Cleaning the Air Filter and Vents](#)

## Solving Image or Sound Problems

Check the solutions in these sections if you have any problems with projected images or sound.

[Solutions When No Image Appears](#)

[Solutions When "No Signal" Message Appears](#)

[Solutions When the Image is Not Rectangular](#)

[Solutions When Only a Partial Image Appears](#)

[Solutions When the Image Contains Noise or Static](#)

[Solutions When the Image is Fuzzy or Blurry](#)

[Solutions When the Image Brightness or Colors are Incorrect](#)

[Solutions to Sound Problems](#)

[Solutions to Bluetooth Audio Problems](#)

**Parent topic:** [Solving Problems](#)

### Solutions When No Image Appears

If no image appears, try the following solutions:

- Check the status light to confirm the projector is operating normally.
- Press the **Blank** button on the remote control to see if the image was temporarily turned off.
- Make sure all necessary cables are securely connected and the power is on for the projector and connected video sources.
- Try using a shorter HDMI cable.
- Try connecting the video source directly to the projector.
- Press the projector's power button to wake it from standby or sleep mode. Also see if your connected computer is in sleep mode or displaying a blank screen saver.
- Make sure the connected device meets the HDMI CEC standard. See the documentation supplied with the device for more information. If necessary, set the CEC function for the connected device again and restart the device. Turn off the projector and the connected streaming device or video source, and then turn them back on.
- Make sure the connected device does not require MHL; the projector's HDMI port does not support MHL.
- If you are projecting from a laptop computer, make sure it is set up to display on an external monitor.

- If you are projecting from a computer using an HDMI cable, turn off the computer and the projector. Make sure the HDMI cable is securely connected, turn the projector on, then turn the computer on.
- Make sure the computer's display resolution does not exceed the projector's resolution and frequency limits. If necessary, select a different display resolution for your computer. (See your computer manual for details.)
- If you are trying to view online content, make sure you have an active Internet connection.
- If the other solutions do not solve the problem, reset all of the projector settings using the options on the **Reset** menu.

**Parent topic:** [Solving Image or Sound Problems](#)

**Related references**

[Projector Light Status](#)

[Projector Parts - Remote Control](#)

**Related tasks**

[Resetting the Projector](#)

[Turning On the Projector](#)

[Operating Connected Devices Using the HDMI Link Features](#)

## Solutions When "No Signal" Message Appears

If the "No Signal" message appears, try the following solutions:

- Press the  Source Search button on the remote control and then select from the displayed sources. Wait a few seconds for an image to appear.
- Turn on the connected computer or video source, and press its play button to begin your presentation, if necessary.
- Check the connection from the projector to your video sources.
- If you are projecting from a laptop computer, make sure it is set up to display on an external monitor.
- If necessary, turn the projector and the connected computer or video source off and then on again.
- If you are projecting from an HDMI source, replace the HDMI cable with a shorter one.
- Connect the video source directly to the projector.
- If the other solutions do not solve the problem, reset all of the projector settings using the option on the **Settings** menu.

[Displaying From a PC Laptop](#)

[Displaying From a Mac Laptop](#)

**Parent topic:** [Solving Image or Sound Problems](#)

**Related tasks**

[Selecting an Image Source](#)

[Resetting the Projector](#)

### Displaying From a PC Laptop

If you see the "No Signal" message when you display from a PC laptop, you need to set up the laptop to display on an external monitor.

1. Hold down the laptop's **Fn** key and press the key labeled with a monitor icon or **CRT/LCD**. (See your laptop manual for details.) Wait a few seconds for an image to appear. To display on both the laptop's monitor and the projector, try pressing the same keys again.

**Note:** On Windows 7 or later, hold down the Windows key and press **P** at the same time, then click **Duplicate**.

2. If the same image is not displayed by the laptop and projector, check the Windows **Display** utility to make sure the external monitor port is enabled and extended desktop mode is disabled. (See your computer or Windows manual for instructions.)
3. If necessary, check your video card settings and set the multiple display option to **Clone**, **Mirror**, or **Duplicate**.

**Parent topic:** [Solutions When "No Signal" Message Appears](#)

### Displaying From a Mac Laptop

If you see the "No Signal" message when you display from a Mac laptop, you need to set up the laptop for mirrored display. (See your laptop manual for details.)

1. Open the **System Preferences** utility and select **Displays**, **Display**, or **Color LCD**.
2. Click the **Arrange** or **Arrangement** tab.
3. Select the **Mirror Displays** checkbox.

**Parent topic:** [Solutions When "No Signal" Message Appears](#)

### Solutions When the Image is Not Rectangular

If the projected image is not evenly rectangular, try the following solutions:

- Press the  Auto Keystone button on the remote control to automatically adjust the image shape.
- Place the projector directly in front of the center of the screen, facing it squarely, if possible.

- Adjust the image shape using the keystone settings in the projector's menu.
- The projector may show a gray shadow around the image. This is normal.

**Parent topic:** [Solving Image or Sound Problems](#)

**Related concepts**

[Projector Placement](#)

**Related tasks**

[Correcting Image Shape with H/V Keystone](#)

[Correcting Image Shape with Corner Adjustment](#)

## Solutions When Only a Partial Image Appears

If only a partial computer image appears, try the following solutions:

- If **Aspect Ratio** in the Picture menu is set to **Zoom**, change it to **Normal**.
- Check your computer display settings to disable dual display and set the resolution within the projector's limits. (See your computer manual for details.)
- Check the resolution assigned to your presentation files to see if they are created for a different resolution than you are projecting in. (See your software help for details.)
- Make sure you selected the correct **Projection** setting in the Display menu.
- If the other solutions do not solve the problem, reset the projector settings.

**Parent topic:** [Solving Image or Sound Problems](#)

**Related references**

[Supported Video Display Formats](#)

**Related tasks**

[Changing the Image Aspect Ratio](#)

[Resetting the Projector](#)

## Solutions When the Image Contains Noise or Static

If the projected image seems to contain electronic interference (noise) or static, try the following solutions:

- Check the cables connecting your computer or video source to the projector. They should be:
  - Separated from the power cord to prevent interference
  - Securely connected at both ends

- Not connected to an extension cable
- Try decreasing the **Sharpness** setting in the **Picture** menu.
- Select a computer video resolution and refresh rate that are compatible with the projector.
- If you connected an extension power cable, try projecting without it to see if it caused interference in the signal.

**Parent topic:** [Solving Image or Sound Problems](#)

**Related references**

[Supported Video Display Formats](#)

**Related tasks**

[Adjusting Picture Quality in Detail](#)

## Solutions When the Image is Fuzzy or Blurry

If the projected image is fuzzy or blurry, try the following solutions:

- Adjust the image focus.
- Clean the projector lens.
- Press the  Auto Keystone button on the remote control.
- Position the projector close enough to the screen, and directly in front of it.
- Position the projector so the keystone adjustment angle is not so wide that it distorts the image.
- Adjust the **Sharpness** setting to improve image quality.
- If you are projecting from a computer, use a lower resolution or adjust the computer's resolution to match the projector's native resolution, if possible.

**Parent topic:** [Solving Image or Sound Problems](#)

**Related references**

[Projection Distance](#)

[Supported Video Display Formats](#)

[Projector Feature Settings - Display Menu](#)

**Related tasks**

[Adjusting Picture Quality in Detail](#)

[Correcting Image Shape with H/V Keystone](#)

[Correcting Image Shape with Corner Adjustment](#)

## Solutions When the Image Brightness or Colors are Incorrect

If the projected image is too dark or light, or the colors are incorrect, try the following solutions:

- Try selecting a color mode that best fits the image and environment.
- Check your video source settings.
- Make sure you selected the correct **HDMI Video Range** setting in the Picture menu, if available for your image source.
- Adjust the **Custom Settings** and **Color Temperature** setting in the Picture Menu for the current input source.
- Make sure all the cables are securely connected to the projector and your video device. If you connected long cables, try connecting shorter cables.
- Position the projector close enough to the screen.

**Parent topic:** [Solving Image or Sound Problems](#)

### Related references

[Available Color Modes](#)

[Image Quality Settings - Picture Menu](#)

### Related tasks

[Adjusting Picture Quality in Detail](#)

[Changing the Color Mode](#)

## Solutions to Sound Problems

If there is no sound when you expect it or the volume is too low or high, try the following solutions:

- Adjust the projector's volume settings.
- Check your computer or video source to make sure the volume is turned up and the audio output is set for the correct source.
- Check the cable connection between the projector and your video source.
- If you want to output audio from the projector's speakers, try setting **Sound Output Device** to **Speaker** and **Sound Output Format** to **PCM** in the Sound menu. Also, make sure the **HDMI2 ARC** setting in the Settings menu is disabled.
- If you want to output audio to an external audio device using an HDMI cable, try the following solutions:
  - Make sure the HDMI cable is connected to the projector's **HDMI2 (ARC)** port



- Enable **HDMI CEC** in the Settings menu
- Enable **HDMI2 ARC** in the Settings menu
- Set **Sound Output Device** to **ARC** in the Sound menu
- Set **Sound Output Format** to **PCM** in the Sound menu
- Make sure the HDMI cable is compliant with HDMI ARC

**Note:** When outputting audio to an external audio device that does not support HDMI ARC using an HDMI cable, disable **HDMI CEC** in the Settings menu.

- If you are using a Mac and you do not hear sound from an HDMI source, make sure your Mac supports audio through the HDMI port. If not, you need to connect an audio cable.
- If you hear a hissing sound from your projector's speakers when projecting from a computer running Windows 10 over a network, you may need to adjust the Windows 10 sound properties:
  1. Right-click the speaker icon in the Windows taskbar and select **Sounds**.
  2. Click the **Playback** tab, select the playback device, and click **Properties**.
  3. Click the **Advanced** tab, set the sample rate and bit depth setting to **16 bit, 44100 Hz (CD Quality)**, click **Apply**, and click **OK**.

**Note:** These steps may vary depending on the Windows 10 version you are using.

- If you turn the projector on immediately after turning it off, the cooling fans may run at high speed momentarily and cause an unexpected noise. This is normal.

**Parent topic:** [Solving Image or Sound Problems](#)

#### **Related tasks**

[Controlling the Volume with the Volume Buttons](#)

[Changing the Sound Mode](#)

## **Solutions to Bluetooth Audio Problems**

If you cannot connect to a Bluetooth audio device, try the following solutions:

- If you cannot connect to Bluetooth output devices such as speakers or headphones, make sure the Bluetooth Speaker mode is disabled. When the projector is in Bluetooth Speaker mode, it is accepting audio source connections and cannot pair to output devices. To connect audio sources such as a smartphone or tablet, make sure Bluetooth Speaker mode is enabled.

- Press the  Bluetooth Speaker mode button on the projector or remote control to enter Bluetooth Speaker mode.
- Select Projector from the available Bluetooth device list displayed on your device.
- Make sure the Bluetooth audio device is paired to the projector and not to another device.
- Make sure only one Bluetooth device is connected to the projector. You cannot connect multiple Bluetooth audio devices to the projector at the same time.
- Make sure the Bluetooth audio device that is paired to the projector supports copyright protection (SCMS-T) and A2DP.
- Make sure the device meets the projector's Bluetooth specifications.
- Make sure the volume level on the paired Bluetooth audio device and projector is turned up.
- If you are having trouble connecting the projector to external Bluetooth speakers, try resetting the speaker's Bluetooth connections and try pairing again.
- Make sure there are no obstacles between the Bluetooth audio device and the projector and that the Bluetooth audio device is within the specified communication distance. Avoid using the projector near wireless networks, microwave ovens, 2.4 GHz cordless phones, or other devices that use the 2.4 GHz frequency band.

**Parent topic:** [Solving Image or Sound Problems](#)

**Related references**

[Bluetooth Specifications](#)

**Related tasks**

[Using the Projector as a Bluetooth Speaker](#)

[Controlling the Volume with the Volume Buttons](#)

## Solving Projector or Remote Control Operation Problems

Check the solutions in these sections if you have problems operating the projector or remote control.

**Note:** For Android TV support, visit <https://support.google.com/androidtv/>.

[Solutions to Projector Power or Shut-Off Problems](#)

[Solutions to Remote Control Problems](#)

**Parent topic:** [Solving Problems](#)

## Solutions to Projector Power or Shut-Off Problems

If the projector does not come on when you press the power button or it shuts off unexpectedly, try the following solutions:

- Make sure the power cord is securely connected to the projector and to a working electrical outlet.
- If the projector's laser shuts off and the Status light is orange, the projector has overheated and shut off. Check the solutions for this light status.
- If the power button on the remote control does not turn on the projector, check its batteries.
- Make sure Sleep Mode is not in effect. Perform any operation to wake the projector. To turn off Sleep Mode, select **Off** as the **Sleep Mode** setting.
- The power cord may be defective. Try another power cord. If that doesn't work, disconnect the cord and contact Epson.
- The cooling fans may run in standby status depending on the projector settings. Also, when the projector wakes from standby status, the fans may cause an unexpected noise. This is not a malfunction.

**Parent topic:** [Solving Projector or Remote Control Operation Problems](#)

### Related references

[Projector Feature Settings - Settings Menu](#)

[Projector Light Status](#)

### Related tasks

[Replacing the Remote Control Batteries](#)

## Solutions to Remote Control Problems

If the projector does not respond to remote control commands, try the following solutions:

- Check that the remote control batteries are installed correctly and have power. If necessary, replace the batteries.
- Make sure you are operating the remote control within the reception angle and range of the projector.
- Make sure the projector is not warming up or shutting down.
- Check to see if a button on the remote control is stuck down, causing it to enter sleep mode. Release the button to wake the remote control up.
- Make sure the remote control is paired to the projector to operate Android TV features. If the pairing screen is displayed, perform pairing again by holding down the **Enter** and  Home buttons on the remote control simultaneously for about three seconds.

- Strong fluorescent lighting, direct sunlight, or infrared device signals may be interfering with the projector's remote receivers. Dim the lights or move the projector away from the sun or interfering equipment.
- If you lose the remote control, you can purchase another from an authorized Epson reseller.

**Parent topic:** [Solving Projector or Remote Control Operation Problems](#)

**Related references**

[Remote Control Operation](#)

[Projector Light Status](#)

[Where to Get Help \(U.S. and Canada\)](#)

[Where to Get Help \(Latin America\)](#)

**Related tasks**

[Replacing the Remote Control Batteries](#)

## Solutions to HDMI Link Problems

If you cannot control an HDMI device using the HDMI Link buttons, try the following solutions:

- Make sure all necessary cables are securely connected and the power is on for the projector and connected video sources.
- Make sure you connect the HDMI cable to the **HDMI2 (ARC)** port.
- Make sure the cables meet the HDMI CEC standard.
- Make sure the connected device meets the HDMI CEC standard. See the documentation supplied with the device for more information.
- Make sure the **HDMI Link** setting is set to **On**.
- Make sure the **HDMI CEC** setting is enabled.
- Make sure the connected devices are turned on and in standby status. See the documentation supplied with the device for more information.
- If you connected a new device or changed any connections, make sure the CEC function is set for the connected device. You may need to restart the device.
- If you have connected a speaker or receiver, set the output to PCM.

**Parent topic:** [Solving Problems](#)

**Related tasks**

[Operating Connected Devices Using the HDMI Link Features](#)

## Solving Network Problems

Check the solutions in these sections if you have problems using the projector on a network.

[Solutions When Wireless Authentication Fails](#)

**Parent topic:** [Solving Problems](#)

### Solutions When Wireless Authentication Fails

If you cannot authenticate a wireless connection, try the following solutions:

- Make sure your Wi-Fi router and modem are working properly. Rebooting these devices may solve the network connection problem.
- Check for obstacles between the Wi-Fi router and the projector and change their positions to improve communication.
- You can check the network settings from the menu displayed when you select the  icon at the top right of the Android TV Home screen.
- If you initialize the projector, you need to select the network settings again on the initial setup screen.

**Parent topic:** [Solving Network Problems](#)

#### Related tasks

[Using the Home Screen](#)

[Resetting the Projector](#)

## Where to Get Help (U.S. and Canada)

If you need to contact Epson for technical support services, use the following support options.

#### Internet Support

Visit Epson's support website at [epson.com/support](http://epson.com/support) (U.S.), [epson.ca/support](http://epson.ca/support) (Canada), or [latin.epson.com/support](http://latin.epson.com/support) (Caribbean) and select your product for solutions to common problems with your projector. You can download utilities and documentation, get FAQs and troubleshooting advice, or e-mail Epson with your questions.

#### Speak to a Support Representative

To use the Epson PrivateLine Support service, call (800) 637-7661. This service is available for the duration of your warranty period. You may also speak with a projector support specialist by dialing (562) 276-4394 (U.S.) or (905) 709-3839 (Canada).

Support hours are 6 AM to 8 PM, Pacific Time, Monday through Friday and 7 AM to 4 PM, Pacific Time, Saturday.

Days and hours of support are subject to change without notice. Toll or long distance charges may apply.

Before you call, have the following information ready:

- Product name
- Product serial number (located on the bottom or rear of the projector, or in the menu system)
- Proof of purchase (such as a store receipt) and date of purchase
- Computer or video configuration
- Description of the problem

### **Purchase Supplies and Accessories**

You can purchase screens, other optional accessories, and replacement parts from an Epson authorized reseller. To find the nearest reseller, call 800-GO-EPSON (800-463-7766) in the U.S. or 800-807-7766 in Canada. Or you can purchase online at [epsonstore.com](http://epsonstore.com) (U.S. sales) or [epsonstore.ca](http://epsonstore.ca) (Canadian sales).

To purchase a replacement remote control, call (562) 276-4394 (U.S.) or (905) 709-3839 (for dealer referral in Canada).

**Parent topic:** [Solving Problems](#)

## **Where to Get Help (Latin America)**

If you need to contact Epson for technical support services, use the following support options.

### **Internet Support**

Visit Epson's support website at [latin.epson.com/support](http://latin.epson.com/support) and select your product for solutions to common problems. You can download utilities and documentation, get FAQs and troubleshooting advice, or e-mail Epson with your questions.

### **Speak to a Support Representative**

Before you call for support, please have the following information ready:

- Product name
- Product serial number (located on the bottom or rear of the projector, or in menu system)
- Proof of purchase (such as a store receipt) and date of purchase
- Computer or video configuration

- Description of the problem

Then call:

<b>Country</b>	<b>Telephone</b>
Argentina	(54 11) 5167-0300 0800-288-37766
Bolivia*	800-100-116
Brazil	State capitals and metropolitan areas: 3004-6627 Other areas: 0800-377-6627 / 0800-EPSONBR
Chile	(56 2) 2484-3400
Colombia	Bogota: (57 1) 592-2200 Other cities: 018000-915235
Costa Rica	800-377-6627
Dominican Republic*	1-888-760-0068
Ecuador*	1-800-000-044
El Salvador*	800-6570
Guatemala*	1-800-835-0358
Mexico	Mexico City: (52 55) 1323-2052 Other cities: 01-800-087-1080
Nicaragua*	00-1-800-226-0368
Panama*	00-800-052-1376
Paraguay	009-800-521-0019
Peru	Lima: (51 1) 418-0210 Other cities: 0800-10-126
Uruguay	00040-5210067
Venezuela	(58 212) 240-1111

\*Contact your local phone company to call this toll-free number from a mobile phone.

**Note:** Toll or long distance charges may apply. If your country does not appear on the list, contact the sales office in the nearest country.

**Purchase Supplies and Accessories**

You can purchase optional accessories and replacement parts from an Epson authorized reseller. To find the nearest reseller, go to [latin.epson.com](http://latin.epson.com). Or you can contact your nearest sales office as described in "Where to Get Help."

**Parent topic:** [Solving Problems](#)



---

# Technical Specifications

These sections list the technical specifications of your projector.

[General Projector Specifications](#)

[Projector Light Source Specifications](#)

[Remote Control Specifications](#)

[Projector Dimension Specifications](#)

[Projector Electrical Specifications](#)

[Projector Environmental Specifications](#)

[Bluetooth Specifications](#)

[Projector Safety and Approvals Specifications](#)

[Supported Video Display Formats](#)

## General Projector Specifications

<b>Type of display</b>	Poly-silicon TFT active matrix
<b>Resolution</b>	1920 × 1080 pixels (Full HD)
<b>Lens</b>	F=2.0 Focal length: 13.9 mm
<b>Color reproduction</b>	Up to 16.77 billion colors
<b>Brightness</b>	Normal light source mode: White light output 1000 lumens (ISO 21118 standard) Color light output 1000 lumens  <b>Note:</b> Color brightness (color light output) and white brightness (white light output) will vary depending on usage conditions. Color light output measured in accordance with IDMS 15.4; white light output measured in accordance with ISO 21118.
<b>Contrast ratio</b>	Over 200,000 with Dynamic Color Mode and Normal light source mode
<b>Image size</b> (in native aspect ratio)	30 inches (0.8 m) to 150 inches (3.8 m)

<b>Projection distance</b> (in native aspect ratio)	60" screen: 52" (1.33 m)
<b>Projection methods</b>	Front, Front/UpSide Down, Rear, Rear UpSide Down
<b>Optical aspect ratio</b> (width-to-height)	16:9
<b>Focus adjustment</b>	Automatic
<b>Auto Keystone Correction - Real Time</b>	Throw distance: 26 to 88 inches (66 to 223.5 cm) Screen size: 30 to 100 inches (76 to 254 cm)
<b>Internal sound system</b>	5 W (Stereo)
<b>Fan noise level</b>	27 dB (Normal power consumption) 22 dB (ECO power consumption)
<b>USB Type A port compatibility</b>	One USB 2.0 compliant port for connecting a USB mass storage device, microphone, human interface device, or web camera
<b>USB Type mini-B port compatibility</b>	One USB 2.0 compliant port for service

Parent topic: [Technical Specifications](#)

## Projector Light Source Specifications

<b>Type</b>	Laser diode
<b>Light source output power</b>	Up to 22.5 W
<b>Wavelength</b>	449 to 461 nm
<b>Light source life</b> (approximate)	Normal Light Source Mode: Up to about 20000 hours Quiet Light Source Mode: Up to about 20000 hours

**Note:** Turn off this product when not in use to prolong the life of the projector. Laser life will vary depending upon mode selected, environmental conditions, and usage. Brightness decreases over time.

Parent topic: [Technical Specifications](#)

## Remote Control Specifications

<b>Reception range</b>	16.4 feet (5 m)
<b>Batteries</b>	Two alkaline or manganese AAA

Parent topic: [Technical Specifications](#)

## Projector Dimension Specifications

<b>Height</b> (excluding feet)	5.0 inches (128 mm)
<b>Width</b>	6.9 inches (175 mm)
<b>Depth</b>	6.9 inches (175 mm)
<b>Weight</b>	Approx. 4.7 lb (2.1 kg)

(not including raised section)

Parent topic: [Technical Specifications](#)

## Projector Electrical Specifications

<b>Rated frequency</b>	50/60 Hz
<b>Power supply</b>	100 to 240 V AC $\pm$ 10% 24 V, 4.1 A
<b>Power consumption</b> (100 to 120 V)	Operating: Normal/Custom Power Consumption mode: 102 W ECO Power Consumption mode: 73 W Standby: 0.5 W (Communication Off), 2.0 W (Communication On)

<b>Power consumption</b> (220 to 240 V)	Operating: Normal/Custom Power Consumption mode: 102 W ECO Power Consumption mode: 73 W Standby: 0.5 W (Communication Off), 2.0 W (Communication On)
--	--

Parent topic: [Technical Specifications](#)

## Projector Environmental Specifications

<b>Temperature</b>	Operating: Up to 7500 feet (2286 m): 41 to 95 °F (5 to 35 °C) 7500 feet (2286 m) to 9843 feet (3000 m): 41 to 86 °F (5 to 30 °C) Storage: 14 to 140 °F (–10 to 60 °C)
<b>Humidity</b> (relative, non-condensing)	Operating: 20 to 80% Storage: 10 to 90%
<b>Operating altitude</b>	Up to 9843 feet (3000 m)

Parent topic: [Technical Specifications](#)

## Bluetooth Specifications

<b>Version</b>	Bluetooth Ver. 5.0
<b>Supported profiles</b>	A2DP, AVRCP, HID, HOGP
<b>Frequency used</b>	2.4 GHz band (2.402 to 2.480 GHz)

**Warning:** Do not use the device near any medical equipment or equipment that is automatically controlled, such as automatic doors or fire alarms. Electromagnetic interference from the device may cause such equipment to malfunction and cause an accident.

Parent topic: [Technical Specifications](#)

## Projector Safety and Approvals Specifications

### United States

FCC Part 15B Class B (DoC)

UL60950-1 2nd edition (cTUVus Mark)

### Canada

ICES-003 Class B

CSA C22.2 No. 60950-1-07 / CSA C22.2 No. 60950-1-14

Parent topic: [Technical Specifications](#)

## Supported Video Display Formats

For best results, your computer's monitor port or video card resolution should be set to display in the projector's native resolution. However, your projector includes Epson's SizeWise chip that supports other computer display resolutions, so your image will be resized to fit automatically.

Your computer's monitor port or video card refresh rate (vertical frequency) must be compatible with the projector. (See your computer or video card manual for details.)

The table here lists the compatible refresh rate and resolution for each compatible video display format.

Display format	Refresh rate (in Hz)	Resolution (in pixels)
<b>HDMI Input Signals</b>		
VGA60	60	640 × 480
SDTV (480i/480p)	59.94	720 × 480
SDTV (576i/576p)	50	720 × 576
HDTV (720p)	50/59.94/60	1280 × 720
HDTV (1080i)	50/59.94/60	1920 × 1080
HDTV (1080p)	23.98/24/29.97/30/50/59.94/60	1920 × 1080
4K	23.98/24/25/29.97/30/50/59.94/60	3840 × 2160
4K (SMPTE)	23.98/24/25/29.97/30/50/59.94/60	4096 × 2160

### Compatible 4K HDR Signals

Refresh rate (in Hz)	Resolution (in pixels)
23.98/24/25/29.97/30/50/59.94/60	1920 × 1080
23.98/24/25/29.97/30	3840 × 2160
23.98/24/25/29.97/30	4096 × 2160

Display format (refresh rate)	Chroma subsampling (pixel encoding)	Color depth: 24 bits (8-bits per pixel)	Color depth: 30 bits (10-bits per pixel)	Color depth: 36 bits (12-bits per pixel)
4K/24p (24 Hz)	4:2:2	SDR	HDR	HDR

**Note:** 12-bit color signals are processed and displayed in 10-bit color.

**Parent topic:** [Technical Specifications](#)

---

## Notices

Check these sections for important notices about your projector.

[Recycling \(U.S. and Canada\)](#)

[Important Safety Information](#)

[Laser Safety Information](#)

[Important Safety Instructions](#)

[List of Safety Symbols](#)

[FCC Compliance Statement](#)

[Binding Arbitration and Class Waiver](#)

[Trademarks](#)

[Copyright Notice](#)

### Recycling (U.S. and Canada)

Epson offers a recycling program for end of life products. Please go to [this site](#) for information on how to return your products for proper disposal.

**Parent topic:** [Notices](#)

### Important Safety Information

**Caution:** Never look into the projector lens when the light source is on. This can damage your eyes and is especially dangerous for children. Before cleaning any part of the projector, turn it off and unplug the power cord. Never open any cover on the projector, except as specifically explained in this manual. Dangerous electrical voltages in the projector can injure you severely. Except as specifically explained in this *User's Guide*, do not attempt to service this product yourself. Refer all servicing to qualified service personnel.

**Warning:** The projector and its accessories come packaged in plastic bags. Keep plastic bags away from small children to avoid any risk of suffocation.

**Parent topic:** [Notices](#)

## Laser Safety Information

This projector is a Class 1 laser product that complies with the IEC/EN60825-1:2014 international standard for lasers. Follow these safety instructions when using the projector.

**Warning:** Possibly hazardous optical radiation emitted from this product. Do not look at operating light source. Eye injury may result.

- If an error occurs in the projector, turn off the power and unplug the projector immediately. Continuing to use the projector could result in an electric shock, fire, or visual impairment. Contact Epson support.
- Do not attempt to disassemble or modify the projector. The projector contains a high-power laser component. Serious injury could result.
- Do not look into the lens during projection. Also, do not look into the lens using optical devices, such as a magnifying glass or telescope. This could cause visual impairment.
- As with any bright source, do not stare into the beam, RG2 IEC/EN 62471-5:2015.
- When turning on the projector at a distance using the remote control, make sure no one is looking into the lens.
- Do not allow small children to operate the projector. Children must be accompanied by an adult.
- Do not apply optical devices, such as a magnifying glass or reflector, to the projected image. Using the projector may result in physical harm, fire, or an accident.
- Before using the projector, make sure there is nothing in the area that could reflect the projected image.
- When disposing of the projector, do not disassemble it. Dispose of the projector in accordance with your local or national laws and regulations.

Complies with FDA performance standards for laser products except for conformance as a Risk Group 2 LIP as defined in IEC 62471-5: Ed. 1.0. For more information see Laser Notice No. 57, dated May 8, 2019.



Laser warning labels are attached to the projector.

- **Inside**



- **Base**

**WARNING:** Never open any covers on the projector except as specifically explained in the projector manual. Dangerous electrical voltages inside the projector can severely injure you.

- **Side**

As with any bright source, do not stare into the beam (RG2 IEC/EN 62471-5:2015).

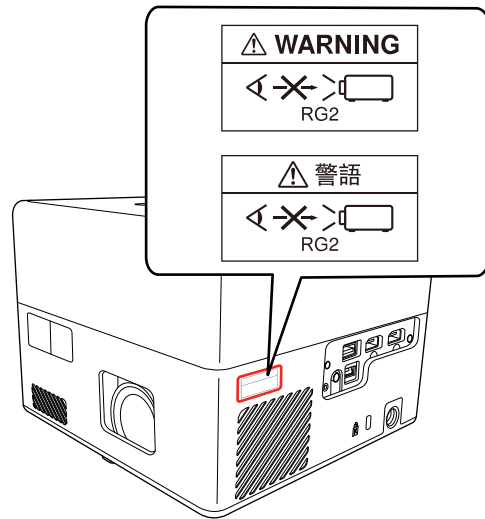

Parent topic: [Notices](#)

## Important Safety Instructions

Follow these safety instructions when setting up and using the projector:

- Do not look into the lens when the projector is on. The bright light can damage your eyes. Avoid standing in front of the projector so the bright light does not shine into your eyes.
- When turning on the projector at a distance using the remote control, make sure there is no one looking into the lens.
- Do not place the projector on an unstable cart, stand, or table.
- Do not install in locations where salt damage could occur, or in locations subject to corrosive gas such as sulphuric gas from hot springs. Otherwise, corrosion could cause the projector to fall. It could also cause the projector to malfunction.
- When installing the projector in a high position, take measures to prevent it from falling by using wires to ensure safety in an emergency, such as an earthquake, and to prevent accidents. If the projector is not installed correctly, the projector could fall. This may result in injury or accidents. Contact your dealer to carry out the installation work.

- When installing or adjusting a ceiling or wall mount, do not use adhesives to prevent the screws from loosening and do not use oils or lubricants. This may cause the projector case to crack and the projector to fall from its ceiling mount. This could cause serious injury to anyone under the mount and could damage the projector.
- Failure to install the mount plate, mounting hardware, and projector may cause the projector to fall. After installing the projector onto VESA compliant (75 × 75mm) mounting hardware using the optional or supplied mount plate (ELPMB65), make sure you secure the mounting hardware to all of the projector's mount plate fixing points. Also, secure the projector and the mounting hardware using wire that is strong enough to hold their weight.
- Do not install the projector in locations exposed to high humidity and dust, such as on a kitchen counter, in the kitchen, or near a humidifier, or in locations exposed to oil smoke or steam. Doing so could cause fire or electric shock.

**Examples of environments that could cause the projector to fall due to case deterioration:**

- Locations subject to excessive smoke or airborne oil particles, such as factories or kitchens
- Locations containing volatile solvents or chemicals, such as factories or laboratories
- Locations where the projector could be subjected to detergents or chemicals, such as factories or kitchens
- Locations in which aroma oils are often used, such as relaxation rooms
- Near devices that produce excessive smoke, airborne oil particles, or foam at events
- Do not use the projector near water, sources of heat, high-voltage electrical wires, or sources of magnetic fields.
- Use the type of power source indicated on the projector. Use of a different power source may result in fire or electric shock. If you are not sure of the power available, consult your dealer or power company.
- Place the projector near a wall outlet where the plug can be easily unplugged.
- Take the following precautions when handling the plug: Do not hold the plug with wet hands. Do not insert the plug into a dusty outlet. Insert the plug firmly into the outlet. Do not pull the power cord when disconnecting the plug; always be sure to hold the plug when disconnecting it. Do not overload wall outlets, extension cords, or power strips. Failure to comply with these precautions could result in fire or electric shock.
- Do not place the projector where the cord can be walked on. This may result in fraying or damage to the plug.
- Unplug the projector from the wall outlet and allow to cool before cleaning. Use a dry cloth (or, for stubborn dirt or stains, a moist cloth that has been wrung dry) for cleaning. Do not use liquid or aerosol cleaners, any sprays containing flammable gas, or solvents such as alcohol, paint thinner, or benzene.

- Do not block the slots and openings in the projector case. They provide ventilation and prevent the projector from overheating. If the vents are covered, the internal temperature could rise and cause a fire. Do not place the projector in locations subject to high temperatures, such as near heating equipment. Do not operate the projector on a sofa, rug, or other soft surface, or set it on top of loose papers. Do not cover the projector with a blanket, curtain, or tablecloth. If you are setting up the projector near a wall, leave at least of space between the wall and the projector.
- Do not operate the projector in a closed-in cabinet unless proper ventilation is provided.
- Never allow objects of any kind to enter any openings in the projector. Do not leave objects, especially flammable objects, near the projector. Never spill liquid of any kind into the projector.
- You may need to clean the air filter and vent. A clogged air filter or vent can block ventilation needed to cool the projector. Do not use canned air, or the gases may leave a residue.
- Do not store the projector outdoors for an extended length of time.
- Except as specifically explained in this manual, do not attempt to service this product yourself. Refer all servicing to qualified personnel. Opening or removing covers may expose you to dangerous voltages and other hazards.
- Never open any covers on the projector except as specifically explained in this manual. Never attempt to disassemble or modify the projector. Refer all repairs to qualified service personnel.
- Unplug the projector from the wall outlet and refer servicing to qualified service personnel under the following conditions: if it does not operate normally when you follow the operating instructions, or exhibits a distinct change in performance; if smoke, strange odors, or strange noises come from the projector; if the power cord or plug is damaged or frayed; if liquid or foreign objects get inside the projector, or if it has been exposed to rain or water; if it has been dropped or the housing has been damaged.
- Do not touch the plug during an electrical storm. Otherwise, you may receive an electric shock.
- Unplug the projector when it will not be used for extended periods.
- Do not use the projector where it may be exposed to rain, water, or excessive humidity.
- Do not use or store the projector where it may be exposed to smoke, steam, corrosive gases, excessive dust, vibration, or shock.
- Do not use the projector where flammable or explosive gases may be present.
- Do not use or store the projector or remote control in a hot location, such as near a heater, in direct sunlight, or in a closed vehicle.
- If you use the projector in a country other than where you purchased it, use the correct power cord for that country.
- Do not stand on the projector or place heavy objects on it.

- Do not use the projector outside of the required temperature range below:  
41 to 95 °F (5 to 35 °C) at an altitude of 7500 feet (2286 m) or less, or 41 to 86 °F (5 to 30 °C) at a higher altitude  
Doing so may cause an unstable display and could lead to projector damage. Do not use or store the projector where it may be exposed to sudden changes in temperature.
- Do not store the projector outside of the required temperature range of 14 to 140 °F (–10 to 60 °C) or in direct sunlight for long periods of time. Doing so may cause damage to the case.
- Do not place anything that can become warped or damaged by heat near the exhaust vents. Do not bring your hands or face close to the vents while projection is in progress. Do not bring your face close to the projector while it is in use.
- Before you move the projector, make sure its power is turned off, the plug is disconnected from the outlet, and all cables are disconnected.
- Do not place the source of an open flame, such as a lit candle, on or near the projector.
- During projection, do not block the light from the projector with a book or other objects. If the light from the projector is blocked, the area on which the light shines becomes hot which could cause it to melt, burn, or start a fire. Also, the lens may get hot due to the reflected light which could cause the projector to malfunction. To stop projection, use the Blank function, or turn off the projector.
- Do not modify the power cord. Do not place heavy objects on top of the power cord or bend, twist, or pull it excessively. Keep the power cord away from hot electrical appliances.
- Always lower the volume before turning off the projector. Turning on the projector with the volume too high can damage your ears.
- Incorrect battery usage may cause leakage of battery fluid and battery rupture, which could result in fire, injury, or corrosion. When replacing batteries, take the following precautions: insert batteries so that the polarities are correct; do not use batteries of different types or mix old and new batteries; do not use any batteries other than those specified; if batteries leak, wipe away battery fluid with a soft cloth; if battery fluid gets on your hands, wash them immediately; replace the batteries as soon as they run out; remove the batteries if you will not be using the projector for a long period of time; do not expose batteries to heat or flame and do not put them in water; dispose of used batteries according to local regulations; keep batteries out of the reach of children. Batteries are choking hazards and are very dangerous if swallowed.
- Under the following conditions, unplug the projector from the outlet and refer all repairs to qualified service personnel. Continuing to use the projector under these conditions may result in fire or electric shock.
  - If smoke is coming from the AC adapter
  - If strange odors or noises come from the AC adapter

- If the AC adapter has been damaged
- If liquid or foreign objects get inside the AC adapter
- Incorrect use of the AC adapter may cause malfunction, fire, or electric shock. Take the following precautions when using the AC adapter:
  - Do not use any AC adapter other than the one supplied with the projector.
  - The supplied AC adapter is designed specifically for this projector model. Do not use it with any other models.
  - Do not apply strong pressure or shocks to the AC adapter.
  - Do not hold the AC adapter with wet hands.
  - Do not install the AC adapter in a narrow space and do not cover it with cloth.
  - Do not touch the AC adapter for a long time while it is energized. It may cause a low-temperature burn.
  - Do not spray flammable gas such as insecticide on the AC adapter.
  - Do not put the AC adapter in a high-pressure container or a cooking appliance such as a microwave oven.
  - Do not place the AC adapter near the projector's air exhaust vent.
  - Do not wind the power cord around the AC adapter.

#### [Restriction of Use](#)

**Parent topic:** [Notices](#)

## **Restriction of Use**







When this product is used for applications requiring high reliability/safety such as transportation devices related to aviation, rail, marine, automotive; disaster prevention devices; various safety devices; or functional/precision devices, you should use this product only after giving consideration to including fail-safes and redundancies into your design to maintain safety and total system reliability.







Because this product was not intended for use in applications requiring extremely high reliability/safety such as aerospace equipment, main communication equipment, nuclear power control equipment, or medical equipment related to direct medical care, please make your own judgment on this product's suitability after a full evaluation.

**Parent topic:** [Important Safety Instructions](#)







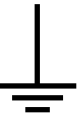

## List of Safety Symbols









The following table lists the meaning of the safety symbols labeled on the equipment.

No.	Symbol	Approved Standards	Description
1		IEC60417 No.5007	"ON" (power) To indicate connection to the mains.
2		IEC60417 No.5008	"OFF" (power) To indicate disconnection from the mains.
3		IEC60417 No.5009	Stand-by To identify the switch or switch position by means of which part of the equipment is switched on in order to bring it into the stand-by condition.
4		ISO7000 No.0434B, IEC3864-B3.1	Caution To identify general caution when using the product.
5		IEC60417 No.5041	Caution, hot surface To indicate that the marked item can be hot and should not be touched without taking care.
6		IEC60417 No.6042 ISO3864-B3.6	Caution, risk of electric shock To identify equipment that has risk of electric shock.
7		IEC60417 No.5957	For indoor use only To identify electrical equipment designed primarily for indoor use.

No.	Symbol	Approved Standards	Description
8		IEC60417 No.5926	Polarity of DC power connector To identify the positive and negative connections (the polarity) on a piece of equipment to which a DC power supply may be connected.
9		—	Polarity of DC power connector To identify the positive and negative connections (the polarity) on a piece of equipment to which a DC power supply may be connected.
10		IEC60417 No.5001B	Battery, general On battery powered equipment. To identify a device for instance a cover for the battery compartment, or the connector terminals.
11		IEC60417 No.5002	Positioning of cell To identify the battery holder itself and to identify the positioning of the cell(s) inside the battery holder.
12		—	Positioning of cell To identify the battery holder itself and to identify the positioning of the cell(s) inside the battery holder.
13		IEC60417 No.5019	Protective earth To identify any terminal which is intended for connection to an external conductor for protection against electric shock in case of a fault, or the terminal of a protective earth electrode.
14		IEC60417 No.5017	Earth To identify an earth (ground) terminal in cases where neither the symbol No.13 is explicitly required.



No.	Symbol	Approved Standards	Description
15		IEC60417 No.5032	Alternating current To indicate on the rating plate that the equipment is suitable for alternating current only; to identify relevant terminals.
16		IEC60417 No.5031	Direct current To indicate on the rating plate that the equipment is suitable for direct current only; to identify relevant terminals.
17		IEC60417 No.5172	Class II equipment To identify equipment meeting the safety requirements specified for Class II equipment according to IEC 61140.
18		ISO 3864	General prohibition To identify actions or operations that are prohibited.
19		ISO 3864	Contact prohibition To indicate injury that could occur due to touching a specific part of the equipment.
20		—	Never look into the optical lens while the projector is on.
21		—	To indicate that the marked item don't place anything on projector.
22		ISO3864 IEC60825-1	Caution, laser radiation To indicate the equipment has a laser radiation part.

No.	Symbol	Approved Standards	Description
23		ISO 3864	Disassembly prohibition To indicate a risk of injury, such as electric shock, if the equipment is disassembled.
24		IEC60417 No. 5266	Standby, partial standby To indicate that part of the equipment is in the ready status.
25		ISO3864 IEC60417 No. 5057	Caution, movable parts To indicate that you must keep away from movable parts according to protection standards.
26		IEC60417 No. 6056	Caution, moving fan blades To indicate that you must keep away from moving fan blades.
27		IEC60417 No. 6043	Caution, sharp corners To indicate that you must not touch sharp corners.
28		—	To indicate that looking into the lens while projecting is prohibited.
29		ISO7010 No. W027 ISO3864	Warning, optical radiation (UV, visible light, IR, etc.) To indicate that you must be careful not to injure your eyes or skin when in the vicinity of optical radiation.
30		IEC60417 No. 5109	Not to be used in residential areas To indicate that the electrical equipment is not suitable for a residential area.

Parent topic: [Notices](#)

## FCC Compliance Statement

### For United States Users

This equipment has been tested and found to comply with the limits for a Class B digital device, pursuant to Part 15 of the FCC Rules. These limits are designed to provide reasonable protection against harmful interference in a residential installation. This equipment generates, uses, and can radiate radio frequency energy and, if not installed and used in accordance with the instructions, may cause harmful interference to radio communications. However, there is no guarantee that interference will not occur in a particular installation. If this equipment does cause interference to radio and television reception, which can be determined by turning the equipment off and on, the user is encouraged to try to correct the interference by one or more of the following measures:

- Reorient or relocate the receiving antenna.
- Increase the separation between the equipment and receiver.
- Connect the equipment into an outlet on a circuit different from that to which the receiver is connected.
- Consult the dealer or an experienced radio/TV technician for help.

This device complies with part 15 of the FCC Rules. Operation is subject to the following two conditions: (1) This device may not cause harmful interference, and (2) this device must accept any interference received, including interference that may cause undesired operation.

### WARNING

The connection of a non-shielded equipment interface cable to this equipment will invalidate the FCC Certification or Declaration of this device and may cause interference levels which exceed the limits established by the FCC for this equipment. It is the responsibility of the user to obtain and use a shielded equipment interface cable with this device. If this equipment has more than one interface connector, do not leave cables connected to unused interfaces. Changes or modifications not expressly approved by the manufacturer could void the user's authority to operate the equipment.

### For Canadian Users

CAN ICES-3(B)/NMB-3(B)

Parent topic: [Notices](#)

# Binding Arbitration and Class Waiver

## 1. DISPUTES, BINDING INDIVIDUAL ARBITRATION, AND WAIVER OF CLASS ACTIONS AND CLASS ARBITRATIONS

1.1 **Disputes.** The terms of this Section 1 shall apply to all Disputes between you and Epson. The term "Dispute" is meant to have the broadest meaning permissible under law and includes any dispute, claim, controversy or action between you and Epson arising out of or relating to this Agreement, Epson branded products (hardware and including any related software), or other transaction involving you and Epson, whether in contract, warranty, misrepresentation, fraud, tort, intentional tort, statute, regulation, ordinance, or any other legal or equitable basis. "DISPUTE" DOES NOT INCLUDE IP CLAIMS, or more specifically, a claim or cause of action for (a) trademark infringement or dilution, (b) patent infringement, (c) copyright infringement or misuse, or (d) trade secret misappropriation (an "IP Claim"). You and Epson also agree, notwithstanding Section 1.6, that a court, not an arbitrator, may decide if a claim or cause of action is for an IP Claim.

1.2 **Binding Arbitration.** You and Epson agree that all Disputes shall be resolved by binding arbitration according to this Agreement. **ARBITRATION MEANS THAT YOU WAIVE YOUR RIGHT TO A JUDGE OR JURY IN A COURT PROCEEDING AND YOUR GROUNDS FOR APPEAL ARE LIMITED.**

Pursuant to this Agreement, binding arbitration shall be administered by JAMS, a nationally recognized arbitration authority, pursuant to its code of procedures then in effect for consumer related disputes, but excluding any rules that permit joinder or class actions in arbitration (for more detail on procedure, see Section 1.6 below). You and Epson understand and agree that (a) the Federal Arbitration Act (9 U.S.C. §1, et seq.) governs the interpretation and enforcement of this Section 1, (b) this Agreement memorializes a transaction in interstate commerce, and (c) this Section 1 shall survive termination of this Agreement.

1.3 **Pre-Arbitration Steps and Notice.** Before submitting a claim for arbitration, you and Epson agree to try, for sixty (60) days, to resolve any Dispute informally. If Epson and you do not reach an agreement to resolve the Dispute within the sixty (60) days, you or Epson may commence an arbitration. Notice to Epson must be addressed to: Epson America, Inc., ATTN: Legal Department, 3131 Katella Ave., Los Alamitos, CA 90720 (the "Epson Address"). The Dispute Notice to you will be sent to the most recent address Epson has in its records for you. For this reason, it is important to notify us if your address changes by emailing us at [EAILEgal@ea.epson.com](mailto:EAILEgal@ea.epson.com) or writing us at the Epson Address above. Notice of the Dispute shall include the sender's name, address and contact information, the facts giving rise to the Dispute, and the relief requested (the "Dispute Notice"). Following receipt of the Dispute Notice, Epson and you agree to act in good faith to resolve the Dispute before commencing arbitration.

1.4 **Small Claims Court.** Notwithstanding the foregoing, you may bring an individual action in the small claims court of your state or municipality if the action is within that court's jurisdiction and is pending only in that court.

**1.5 WAIVER OF CLASS ACTIONS AND CLASS ARBITRATIONS. YOU AND EPSON AGREE THAT EACH PARTY MAY BRING DISPUTES AGAINST THE OTHER PARTY ONLY IN AN INDIVIDUAL CAPACITY, AND NOT AS A PLAINTIFF OR CLASS MEMBER IN ANY CLASS OR REPRESENTATIVE PROCEEDING, INCLUDING WITHOUT LIMITATION FEDERAL OR STATE CLASS ACTIONS, OR CLASS ARBITRATIONS. CLASS ACTION LAWSUITS, CLASS-WIDE ARBITRATIONS, PRIVATE ATTORNEY-GENERAL ACTIONS, AND ANY OTHER PROCEEDING WHERE SOMEONE ACTS IN A REPRESENTATIVE CAPACITY ARE NOT ALLOWED. ACCORDINGLY, UNDER THE ARBITRATION PROCEDURES OUTLINED IN THIS SECTION, AN ARBITRATOR SHALL NOT COMBINE OR CONSOLIDATE MORE THAN ONE PARTY'S CLAIMS WITHOUT THE WRITTEN CONSENT OF ALL AFFECTED PARTIES TO AN ARBITRATION PROCEEDING.**

**1.6 Arbitration Procedure.** If you or Epson commences arbitration, the arbitration shall be governed by the rules of JAMS that are in effect when the arbitration is filed, excluding any rules that permit arbitration on a class or representative basis (the "JAMS Rules"), available at <http://www.jamsadr.com> or by calling 1-800-352-5267 (U.S. or Canada), or <https://www.jamsadr.com/about/> or by calling +1-949-224-1810 (Latin America), and under the rules set forth in this Agreement. All Disputes shall be resolved by a single neutral arbitrator, and both parties shall have a reasonable opportunity to participate in the selection of the arbitrator. The arbitrator is bound by the terms of this Agreement. The arbitrator, and not any federal, state or local court or agency, shall have exclusive authority to resolve all disputes arising out of or relating to the interpretation, applicability, enforceability or formation of this Agreement, including any claim that all or any part of this Agreement is void or voidable. Notwithstanding this broad delegation of authority to the arbitrator, a court may determine the limited question of whether a claim or cause of action is for an IP Claim, which is excluded from the definition of "Disputes" in Section 1.1 above. The arbitrator shall be empowered to grant whatever relief would be available in a court under law or in equity. The arbitrator may award you the same damages as a court could, and may award declaratory or injunctive relief only in favor of the individual party seeking relief and only to the extent necessary to provide relief warranted by that party's individual claim. In some instances, the costs of arbitration can exceed the costs of litigation and the right to discovery may be more limited in arbitration than in court. The arbitrator's award is binding and may be entered as a judgment in any court of competent jurisdiction.

You may choose to engage in arbitration hearings by telephone. Arbitration hearings not conducted by telephone shall take place in a location reasonably accessible from your primary residence, or in Orange County, California, at your option.

a) Initiation of Arbitration Proceeding. If either you or Epson decides to arbitrate a Dispute, both parties agree to the following procedure:

(i) Write a Demand for Arbitration. The demand must include a description of the Dispute and the amount of damages sought to be recovered. You can find a copy of a Demand for Arbitration at <http://www.jamsadr.com> ("Demand for Arbitration").

(ii) Send three copies of the Demand for Arbitration, plus the appropriate filing fee, to: JAMS, 500 North State College Blvd., Suite 600 Orange, CA 92868, U.S.A.

(iii) Send one copy of the Demand for Arbitration to the other party (same address as the Dispute Notice), or as otherwise agreed by the parties.

b) Hearing Format. During the arbitration, the amount of any settlement offer made shall not be disclosed to the arbitrator until after the arbitrator determines the amount, if any, to which you or Epson is entitled. The discovery or exchange of non-privileged information relevant to the Dispute may be allowed during the arbitration.

c) Arbitration Fees. Epson shall pay, or (if applicable) reimburse you for, all JAMS filings and arbitrator fees for any arbitration commenced (by you or Epson) pursuant to provisions of this Agreement.

d) Award in Your Favor. For Disputes in which you or Epson seeks \$75,000 or less in damages exclusive of attorney's fees and costs, if the arbitrator's decision results in an award to you in an amount greater than Epson's last written offer, if any, to settle the Dispute, Epson will: (i) pay you \$1,000 or the amount of the award, whichever is greater; (ii) pay you twice the amount of your reasonable attorney's fees, if any; and (iii) reimburse you for any expenses (including expert witness fees and costs) that your attorney reasonably accrues for investigating, preparing, and pursuing the Dispute in arbitration. Except as agreed upon by you and Epson in writing, the arbitrator shall determine the amount of fees, costs, and expenses to be paid by Epson pursuant to this Section 1.6d).

e) Attorney's Fees. Epson will not seek its attorney's fees and expenses for any arbitration commenced involving a Dispute under this Agreement. Your right to attorney's fees and expenses under Section 1.6d) above does not limit your rights to attorney's fees and expenses under applicable law; notwithstanding the foregoing, the arbitrator may not award duplicative awards of attorney's fees and expenses.

**1.7 Opt-out. You may elect to opt-out (exclude yourself) from the final, binding, individual arbitration procedure and waiver of class and representative proceedings specified in this Agreement by sending a written letter to the Epson Address within thirty (30) days of your assent to this Agreement (including without limitation the purchase, download, installation of the Software or other applicable use of Epson Hardware, products and services) that specifies (i) your name, (ii) your mailing address, and (iii) your request to be excluded from the final, binding individual arbitration procedure and waiver of class and representative proceedings specified in this Section 1. In the event that you opt-out consistent with the procedure set forth above, all other terms shall continue to apply, including the requirement to provide notice prior to litigation.**

**1.8 Amendments to Section 1.** Notwithstanding any provision in this Agreement to the contrary, you and Epson agree that if Epson makes any future amendments to the dispute resolution procedure and class action waiver provisions (other than a change to Epson's address) in this Agreement, Epson will obtain your affirmative assent to the applicable amendment. If you do not affirmatively assent to the applicable amendment, you are agreeing that you will arbitrate any Dispute between the parties in

accordance with the language of this Section 1 (or resolve disputes as provided for in Section 1.7, if you timely elected to opt-out when you first assented to this Agreement).

**1.9 Severability.** If any provision in this Section 1 is found to be unenforceable, that provision shall be severed with the remainder of this Agreement remaining in full force and effect. **The foregoing shall not apply to the prohibition against class or representative actions as provided in Section 1.5. This means that if Section 1.5 is found to be unenforceable, the entire Section 1 (but only Section 1) shall be null and void.**

Parent topic: [Notices](#)

## Trademarks

EPSON® and Quick Corner® are registered trademarks and EPSON Exceed Your Vision is a registered logomark of Seiko Epson Corporation.

SizeWise™ is a trademark of Epson America, Inc.

Windows is a registered trademark of Microsoft Corporation in the United States and/or other countries.

Apple and Mac are trademarks of Apple Inc., registered in the U.S. and other countries.

Google, Google Home, YouTube, Chromecast, and Android TV are trademarks of Google LLC.

General Notice: Other product names used herein are for identification purposes only and may be trademarks of their respective owners. Epson disclaims any and all rights in those marks.



Parent topic: [Notices](#)

## Copyright Notice

All rights reserved. No part of this publication may be reproduced, stored in a retrieval system, or transmitted in any form or by any means, electronic, mechanical, photocopying, recording, or otherwise, without the prior written permission of Seiko Epson Corporation. The information contained herein is designed only for use with this Epson product. Epson is not responsible for any use of this information as applied to other products.

Neither Seiko Epson Corporation nor its affiliates shall be liable to the purchaser of this product or third parties for damages, losses, costs, or expenses incurred by purchaser or third parties as a result of: accident, misuse, or abuse of this product or unauthorized modifications, repairs, or alterations to this

product, or (excluding the U.S.) failure to strictly comply with Seiko Epson Corporation's operating and maintenance instructions.

Seiko Epson Corporation shall not be liable for any damages or problems arising from the use of any options or any consumable products other than those designated as Original Epson Products or Epson Approved Products by Seiko Epson Corporation.

This information is subject to change without notice.

[A Note Concerning Responsible Use of Copyrighted Materials](#)  
[Copyright Attribution](#)

**Parent topic:** [Notices](#)

## **A Note Concerning Responsible Use of Copyrighted Materials**

Epson encourages each user to be responsible and respectful of the copyright laws when using any Epson product. While some countries' laws permit limited copying or reuse of copyrighted material in certain circumstances, those circumstances may not be as broad as some people assume. Contact your legal advisor for any questions regarding copyright law.

**Parent topic:** [Copyright Notice](#)

## **Copyright Attribution**

© 2020 Epson America, Inc.

10/20

CPD-59719

**Parent topic:** [Copyright Notice](#)